

RICOH

G700SE

Software User Guide



Note

- Read all safety precautions thoroughly to ensure safe use.
- Types of software installed on your computer varies depending on the method of installation from the Software CD-ROM. For details, see the "Camera User Guide"
- For information on the operating systems that support the Software CD-ROM, see the "Camera User Guide".

Using These Manuals

The two manuals included are for your G700SE.

1. Understanding How to Use Your Camera

“Camera User Guide” (Printed manual)

This guide explains the usage and functions of the camera. You will also see how to install the provided software on your computer.

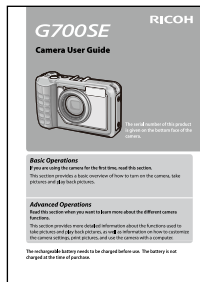

2. Downloading Images to Your Computer

“Software User Guide”

*This manual (this file)

This guide explains how to download images from the camera to your computer.



3. Displaying Images on Your Computer

The provided software “MediaBrowser” (for Windows only) allows you to display and edit images on your computer.

For details on how to use MediaBrowser, click the [?] button on the MediaBrowser window and see the “Help”

For the latest information about MediaBrowser, access the Web page of Pixela Co., Ltd. (<http://www.pixela.co.jp/oem/mediabrowser/e/>).

How to Use the Software User Guide

Display examples:

The display examples may be different from actual display screens.

Terms:

In this guide, still images and movies are referred to as “images” or “files”.

Symbols:

This guide uses the following symbols and conventions:



This indicates important notices and restrictions for using this camera.



This indicates supplementary explanations and useful tips about camera operations.



This indicates page(s) relevant to a particular function. “P. xx” is used to refer you to pages in this manual.



This indicates terms that are useful for understanding the explanations.

Contents

Using These Manuals	2
How to Use the Software User Guide	2
Contents.....	3

Chapter 1 Downloading Images to Your Computer (Windows)

Downloading Images	5
Downloading Images Without Using DL-10	6
Downloading All Images Using the DL-10 Software.....	7
Warning Messages Under Windows XP Service Pack 3 and Windows Vista Service Pack 2.....	8
Windows 7 Security Warning.....	9
Disconnecting the Camera from Your Computer...	9
Detailed Instructions for DL-10	9
Starting/Exiting DL-10.....	9
The DL-10 Window	10
How to Use the [Option settings]	11
How to Use the [Background illustration settings]...	12
Using [CameraMemo Settings]	12
Downloading Images from an SD Memory Card...	13
Images in an SD Memory Card.....	13

Chapter 2 Downloading Images to Your Computer (Macintosh)

Connecting the Camera to a Computer and Downloading Images	15
Disconnecting the Camera from Your Computer...	16
Downloading Images from an SD Memory Card...	16
Images in an SD Memory Card.....	16

Chapter 3 How to Use EC1

Using the Edit Detection Function	18
Updating Folder Contents.....	18

Chapter 4 Shooting with Camera Memos

Section 1 About Camera Memos

Shooting with Camera Memos.....	20
Memos.....	20
Using Memos.....	21

Section 2 Creating and Transferring a Memo List

Creating a Camera Memo List	23
Starting and Exiting List Editor.....	23
The List Editor Dialog.....	23
Using the List Editor	24

Transferring a Memo List File to the Camera	26
The List Editor	26
Card Readers.....	26
Deleting Memo List Files From Memory Cards	26

Section 3 Taking Photographs with Memos

Recording Memos with Photographs.....	27
Adding Memos to New Photos	27
Choosing Descriptions	28
Viewing Memos	29
Viewing Memos	29
Editing Memos	29
Creating a Temporary Memo	30
Creating a Temporary Memo	30
Editing the Temporary Memo.....	31
Creating a Temporary Memo from an Existing Memo	31
Memo Increment	32
Using Memo Increment	32
Using Memo Increment with Temporary Memos ...	33
Voice Memos.....	33
Recording Voice Memos.....	33
Playing Voice Memos.....	34
Re-recording Voice Memos	35
Registering Barcode Data as a Temporary Memo...	36
Choosing a Barcode Mode	36
Reading a Barcode and Registering Barcode Data...	36
Image Memos.....	38
First Steps	38
Viewing Image Memos.....	39

Section 4 Viewing/Editing a Camera Memo on a Computer

Using ME1.....	40
The ME1 Window	40
Editing Memos	40
Printing Memos with Photographs.....	41

Section 5 Using Memos to Sort Photos

Using EX1	42
EX1 Operation Flow.....	42
Starting and Exiting EX1	42
Transfer Settings	43
Processing Photos	45
Property	45
File Information.....	46

Appendices

How to Use the Keyboard.....	49
Troubleshooting	50

Chapter 1

Downloading Images to Your Computer (Windows)

This section explains how to download still images and movies to your computer (Windows).

Downloading Images

There are two methods for downloading images from the camera to your computer.

1. Downloading images without using image download software such as DL-10 (👉 P.6).

The camera is recognized by the computer as a separate drive and appears on [My Computer]. Select and copy images.

2. Use image downloading software such as DL-10 to download all images to the computer (👉 P.7).

To use DL-10, DC Software must be installed. For information on how to install DC Software, see the "Camera User Guide".

Caution

- Do not turn off the camera or disconnect the USB cable during image transfer. The files will not be written correctly.
- Do not use the computer to format the SD memory card or the internal memory. Use the camera to format the SD memory card or the internal memory.
- Be sure to stop the connection before removing the USB cable.
- The camera can not display pictures that have been transferred to the computer using "Windows Photo Gallery" (Windows Vista) or "Windows Live Photo Gallery" (Windows 7) and then copied from the computer to a memory card which is subsequently inserted in the camera.
- Only one Ricoh digital camera can be connected to one computer. Do not connect multiple Ricoh cameras to one computer at the same time.

- The names for DC Software items differ from the names for Caplio Software items provided with previous models as shown below.

Caplio Software	DC Software
RICOH Gate La	DL-10
Caplio Viewer	DU-10
Caplio Server	SR-10
Caplio Setting	ST-10

Note

- When downloading images from your camera, load a battery with adequate remaining power in the camera.
- If there is an SD memory card in the camera, images will be loaded from the card. If there is no SD memory card in the camera, images will be loaded from the internal memory on the camera.
- The software included in the CD-ROM can only be used with Windows.

Downloading Images Without Using DL-10

1. Make sure that the camera power is off.
2. Connect the accessory USB cable to a USB port of your computer.

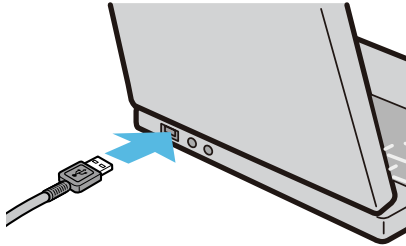

3. Connect the USB cable to the USB terminal of your camera.

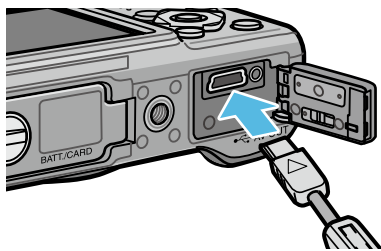

Your camera turns on.
Your computer automatically reads the file necessary for recognizing the camera as a drive.
After this preparation, the camera is displayed as a drive at [My Computer].



Example of the display in Windows XP

4. From the displayed drive, copy a file to the desired location.

The figure below shows the folder configuration of the drive.

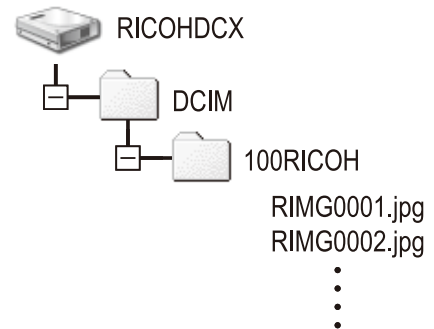

When the contents of the internal memory are displayed, the drive name is [RICOHDCI].

Note

- If a file with the same name already exists at the destination, it is overwritten.
- If DC Software is installed, clear the check box next to the [Saves automatically when connected to USB] option in the DL-10 [Option settings] dialog box.

Downloading All Images Using the DL-10 Software

DL-10 automatically creates a folder called [Digital Camera] inside your [My Documents] folder. Downloaded images are saved in folders with the date of each shot, inside the [Digital Camera] folder. (The files will continue to be saved in the [Caplio] folder if you were previously using Caplio Software.)

Set the correct date and time on the camera before shooting.

1. Make sure that the camera power is off.
2. Connect the USB cable to the USB port of your computer.

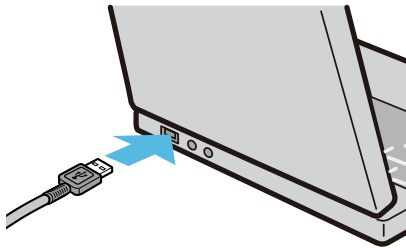

3. Connect the USB cable to the USB terminal of your camera.

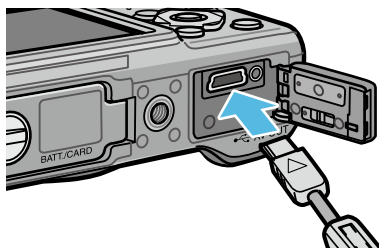

The camera turns on, DL-10 starts, and the DL-10 window appears.



Image transfer begins automatically.

If image transfer does not begin, please try the following procedures:

- Click the [Save] button in the DL-10 window.
- Restart your computer and perform Steps 1 to 3 again.
- Confirm that the [Saves automatically when connected to USB] checkbox in the [Option settings] dialog box for DL-10 is selected.

Caution

- When the [The same image will not be saved] check box is selected in DL-10 [Option settings] (P.11), the total number of files that can be transferred at one time is 999. To transfer 1000 files or more, transfer 999 files first and then click [OK] when the dialog box with the number of remaining files appears. After that, click the [Save] button in the DL-10 window or reconnect the USB cable to transfer the remaining files.
- Do not turn off the camera or disconnect the USB cable during image transfer using DL-10 (when the message for receiving data is displayed).

Note

- The images on the computer are renamed using consecutive file numbers; the file names assigned by the camera are not used.
- Even when the storage folder is changed, the file number will be continuous. The number cannot be initialized.
- When transferring images to a computer using DL-10, the files are assigned names like [RIMG****.jpg] (**** indicates the number of the image), even if [Card Sequence No.] is set to [On].

Reference

- For details about DL-10, see P.9.
- For details about the DL-10 [Option settings] dialog box, see P.11.
- To disconnect the camera from your computer, see P.9.

Warning Messages Under Windows XP Service Pack 3 and Windows Vista Service Pack 2

When software for your Ricoh digital camera is used on a computer running Windows Vista Service Pack 2 or on a computer with Windows XP Service Pack 3 installed, a warning message similar to the one shown below may appear at software activation or USB connection. Change the computer settings while referring to the information below.

A screenshot of the warning message in Windows XP is shown below.

When warning messages appear:

After checking the program name and publisher, click [Unblock].



Caution

If you do not recognize the program, you should block it because it may be a virus. Click the [Keep Blocking] button to prevent the program from connecting to the Internet.

If you clicked the [Ask Me Later] button:

Each time the program is activated, the [Windows Security Alert] window appears. Then you can select [Unblock].

If you clicked the [Keep Blocking] button: Follow the steps below to check to see the Windows Firewall settings.

1. Open the [Windows Firewall] Control Panel.



Open the [Start] menu and select [Control Panel], then double-click [Windows Firewall] (if Windows Firewall is not listed, click [Switch to Classic View] at the top left corner of the Control Panel window).

2. Allow the Ricoh application Internet access.

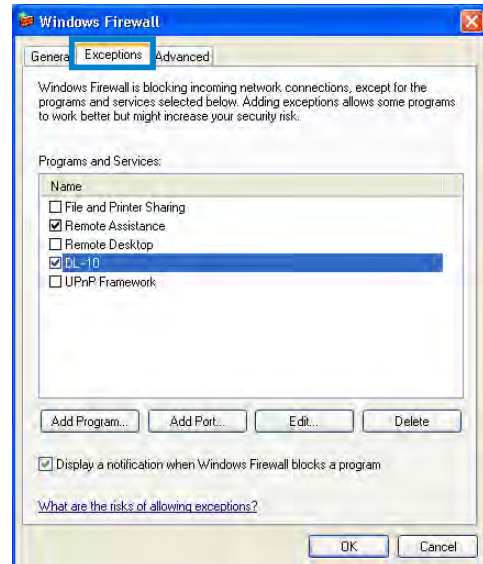

In the [Windows Firewall] dialog, click the [Exceptions] tab and check whether DL-10 is listed under [Programs and Services]. If it is, place a check in the check box next to DL-10 and click OK. If it is not listed, click [Add Program...] to add DL-10 to the list of exceptions.

Windows 7 Security Warning

On computers running Windows 7, you may encounter the following warning when starting Ricoh software for digital cameras either manually or by connecting a camera:

When warning messages appear:

After checking the program name and publisher, click [Allow access].

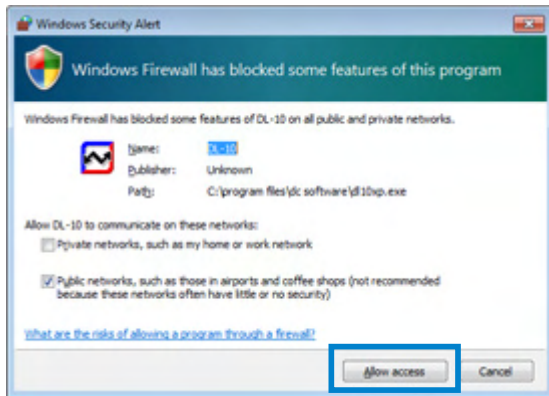

Disconnecting the Camera from Your Computer

Before disconnecting the camera from the computer, click the [Safely Remove Hardware] or [Unplug or Eject Hardware] icon in the taskbar (the illustration below shows the icon for Windows XP) and select [Safely remove USB Mass Storage Device] or [Stop USB Mass Storage Device] from the menu that appears. You can then disconnect the USB cable.



If the remove hardware icon is not displayed in Windows 7, click the  button in the taskbar.



Note

- If the USB cable is disconnected without disabling the connection, the Unsafe Removal of Device screen may be displayed.
- Do not disconnect the USB cable during image transfer. Check that image transfer is completed and be sure to stop the connection before removing the USB cable.

Detailed Instructions for DL-10

Starting/Exiting DL-10

Starting

DL-10 is already installed with DC Software.

Connecting the camera to your computer automatically starts the software and begins downloading of images from the camera.

Exiting

To exit DL-10, follow either of the steps below.

- Click the [MENU] button on the DL-10 window and select [Exit] from the displayed menu (see "The DL-10 Window").
- Right-click the DL-10 icon on the task bar and select [Exit] from the displayed menu.

Restarting

To restart DL-10 after exiting, follow the steps below.

- From the [Start] menu, select [All Programs] or [Programs] then [DC Software] then [DL-10].

Caution

DL-10 is not network-compatible. Use as a stand-alone application.

The DL-10 Window

Once DL-10 starts up, the following DL-10 window appears on your computer screen.



1 [MENU] Button

Click this and the following menu appears.

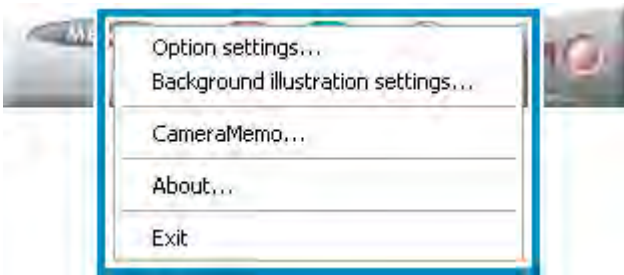

[Option settings]	Specifies where to save images when downloading all images and which application to start after images have been saved or when the [Application] button is clicked. (☞ P.11)
[Background illustration settings]	Changes the background design in the DL-10 window. (☞ P.12)
[CameraMemo]	Transfer images (☞ P.19) to destinations selected based on the presence or absence of a memo (☞ P.12) and memo contents.
[About]	Displays the version of DL-10.
[Exit]	Closes DL-10.

2 [Save] Button

Click this and the images are downloaded from your camera.

Caution

If the message indicating that [Connecting... Press [Adj.] key to direct print] appears on the camera picture display, do not click the [Save] button.

3 [Application] Button

The application registered in [Option settings] is started.

4 [Minimize] Button

Minimizes the window and displays its icon on the Windows task bar. If you click on the icon, the window will be displayed again.

5 Indicator

The "Indicator" lights if the camera is connected via USB cable. When lit, if you move the mouse pointer over the "Indicator", [Camera is being connected] appears. When your camera is not connected, the "Indicator" is grayed out, and if you move the mouse pointer over it, [Camera is being connected] does not appear.

How to Use the [Option settings]

If you click the [MENU] button on the DL-10 window and select [Option settings] from the displayed menu, the [Option settings] dialog box appears.

Caution

Note that uninstalling the software for earlier Ricoh cameras may reset user preferences for DL-10 or RICOH Gate La.

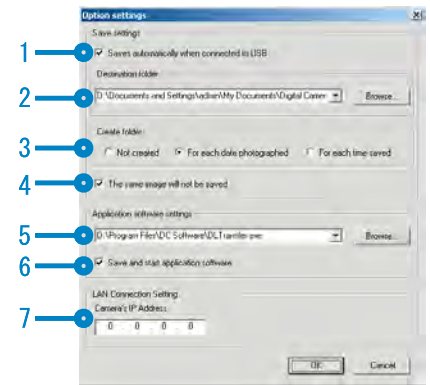

Item	Description	Initial Setting
1 [Saves automatically when connected to USB]	Select the check box to have images downloaded and saved automatically in your computer when the camera is connected to your computer with the USB cable. If you deselect the check box, your images will not be downloaded automatically when you connect your camera to the computer. For downloading, activate DL-10 and click the [Save] button.	Save automatically
2 [Destination folder]	Specifies which folder to save your images in. The [Digital Camera] folder inside [My Documents] is specified initially; if you want to change this, click the [Browse...] button to display the dialog box and then specify the folder.	_____
3 [Create folder]	Specifies how to create a folder. [Not created] Your downloaded images will all be saved in the folder specified in item "2 [Destination folder]". [For each date photographed] Creates a new folder assigning the date the images were shot as the folder name, and saves images shot on the same day in the same folder. For example, if shot on January 1, 2010: [20100101] folder [For each time saved] Creates a new folder each time and save images in the folder. If images are saved more than once in a day, a new folder is created each time. The folder name format is "Saving date + Underscore + Three-digit serial number". For example, if you saved twice on January 1, 2010: [20100101_001] folder, [20100101_002] folder	Create a new folder for each date photographed
4 [The same image will not be saved]	When this check box is selected, images once loaded into your computer are not loaded again. This check box is enabled only when [Not created] or [For each date photographed] is selected in [Create folder]. To allow this function to work properly, the camera date and time must be set correctly. When this check box is deselected, previously loaded images are loaded again. * If you were previously using Caplio Software, images will be downloaded again if images downloaded using RICOH Gate La remain on the SD memory card even if the [The same image will not be saved] checkbox for the DL-10 [Option settings] is selected.	The same image will not be saved
5 [Application software settings]	To start an application after loaded images have been saved, specify the application name here. Click the [Browse...] button and select the application in the displayed dialog box.	_____
6 [Save and start application software]	When this is checked, the application specified above is started after the images have been saved. When this is unchecked, the application is not started.	Application is started
7 [Camera's IP Address]	Not used for this camera, but used for other Ricoh digital cameras. For details, see the documentation that came with the camera.	0.0.0.0

How to Use the [Background illustration settings]

You can select a background for the DL-10 window from three types of patterns.

If you click the [MENU] button on the DL-10 window and select [Background illustration settings] from the displayed menu, the [Background illustration settings] dialog box appears.

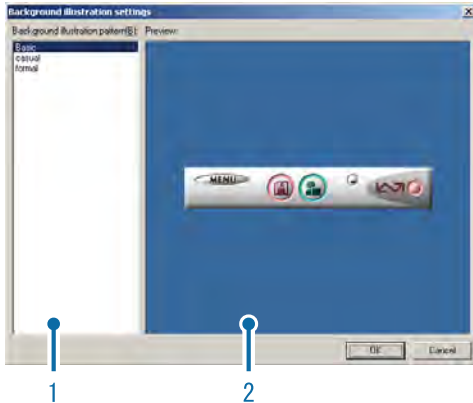

1 [Background illustration pattern]

Select the pattern you wish to use from the three available.

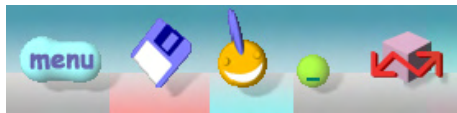

2 [Preview]

You can preview the pattern selected in [Background illustration pattern].

Using [CameraMemo Settings]

Transfer images to destinations selected based on the presence or absence of memos and memo contents. Click the [MENU] button and select [CameraMemo] to display the [CameraMemo Settings] dialog.

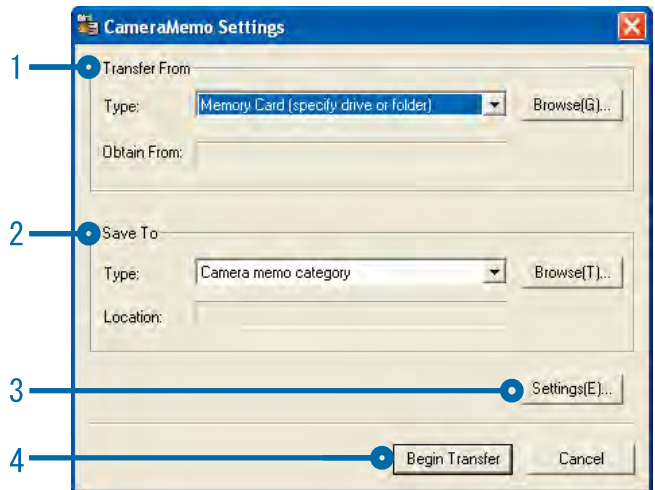

1 [Transfer From]

Choose the source from [Memory Card (specify drive or folder)] and [Digital Camera] in the [Type] menu. If you select [Memory card (specify drive or folder)], click the [Browse...] button and navigate to the desired source folder.

2 [Save To]

Click [Browse...] and choose the destination for the transferred files. The destination type is fixed and can not be changed.

3 [Settings...]

Clicking this button displays the [Setting Information] dialog, where you can adjust each of the transfer settings listed below by double-clicking the setting or by selecting the setting and clicking [Change...].

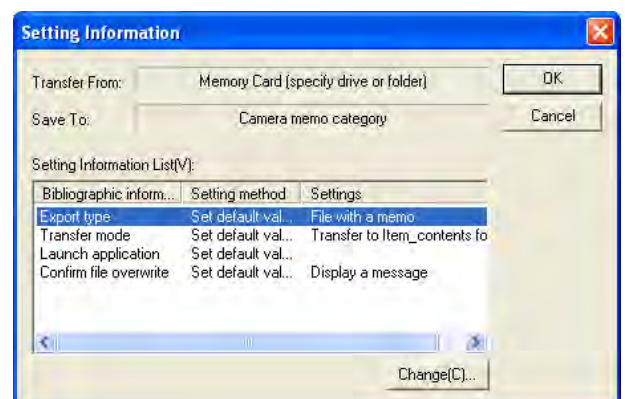

[Overwrite and save] (available only when [Digital Camera] is selected for [Transfer From])	Choose whether to include images that have already been transferred to the destination. Select [Do not save the same image] to skip images that have already been transferred.
[Export type] (available only when [Memory Card] is selected for [Transfer From])	Choose whether to transfer all images or only those with memos.
[Transfer mode]	Choose whether the sub-folders in the destination folder are named by memo description or using both memo item names and descriptions.
[Launch application]	Choose the application that starts when transfer is complete.
[Confirm File Overwrite]	Choose whether a confirmation dialog is displayed before files in the destination folder are overwritten by transferred files with the same name. If you opt not to display a confirmation dialog, files will be overwritten without warning. If [Digital Camera] is selected for [Transfer From], a confirmation dialog will only be displayed if [Save the same image] is selected.

4 [Begin Transfer]

Click this button to begin transfer (clicking this button is the only way to begin transfer using [CameraMemo Settings]).

Note

Reserved characters (\ / ; ? * " < > |) are automatically converted to underscores ("_") when memo item names and descriptions are used as folder names.

Downloading Images from an SD Memory Card

It is possible to download images from an SD memory card to computer via a PC card slot or card reader.

Images in an SD Memory Card

Images are stored on an SD memory card in a hierarchy, as shown here.

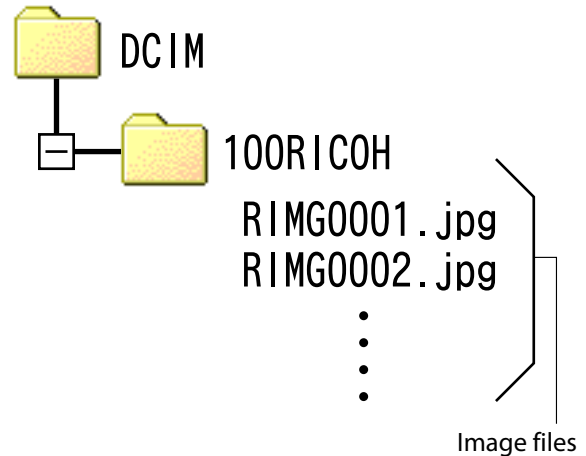

Caution

If you connect the camera or a card reader to a computer and then directly display, edit or save SD memory card images on the computer, you may no longer be able to play back the images on the camera. Download the images to the computer before displaying, editing or saving them.

Terms

Card Reader

This is a device connected to a computer to read the contents of cards. In addition to the memory card adapter-type, there are card readers into which you can directly load an SD memory card.

Chapter 2

Downloading Images to Your Computer (Macintosh)

This section explains how to download still images and movies to your computer (Macintosh).



Caution

Although supplied software can not be used on the Macintosh, Macintosh computers can be used to view the “Software User Guide” (Acrobat Reader required under Mac OS 9).

Connecting the Camera to a Computer and Downloading Images

1. Make sure that the camera power is off.
2. Connect the accessory USB cable to a USB port of your computer.

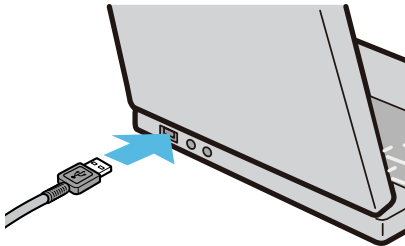

3. Connect the USB cable to the USB terminal of your camera.

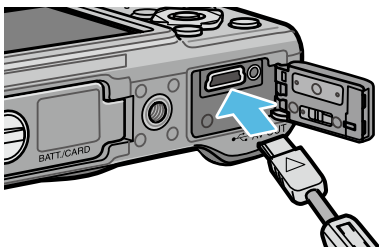

Your camera turns on.
Your computer automatically reads the file necessary for recognizing the camera as a drive.
After this preparation, the camera is displayed as a drive on the Desktop.

4. From the displayed drive, copy a file to the desired location.

The figure below shows the folder configuration in the drive.

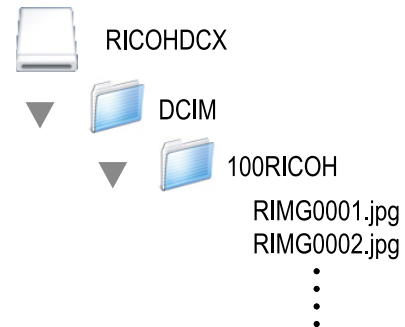

When the contents of the internal memory are displayed, the drive name is [RICOHDCI].

Caution

- Do not turn off the camera or disconnect the USB cable during image transfer. The files will not be written correctly.
- Do not use the computer to format the SD memory card or the internal memory. Use the camera to format the SD memory card or the internal memory.
- Be sure to stop the connection before removing the USB cable.
- Only one Ricoh digital camera can be connected to one computer. Do not connect multiple Ricoh cameras to one computer at the same time.

Note

- When downloading images from your camera, load a battery with adequate remaining power in the camera.
- If a file with the same name already exists at the destination, it is overwritten. If you do not want the file to be overwritten, rename the file or transfer data to another folder.
- When an SD memory card is loaded, its files are displayed. Otherwise, files in the internal memory are displayed.

Disconnecting the Camera from Your Computer

1. Drag and drop the displayed drive or volume icon to the [Trash] icon.

When a screen appears prompting you to enter the administrator's password, enter the password.

2. Unplug the USB cable.

Note

- You can also select [Eject] from the [Special] menu in Mac OS 9 or the [File] menu in Mac OS X to cancel the connection.
- A warning may be displayed if the USB cable is disconnected without first removing the camera from the system as described above. Be sure to remove the camera from the system before disconnecting the cable.
- Confirm that transfer is complete before removing the camera from the system and disconnecting the cable.
- When the camera is connected to a Macintosh computer, a "FINDER.DAT" or ".DS_Store" file may be created which the camera will list as an unmatched file. This file can be deleted without risk.

Downloading Images from an SD Memory Card

It is possible to download images from an SD memory card to computer via a PC card slot or card reader.

Images in an SD Memory Card

Images are stored on an SD memory card in a hierarchy, as shown here.

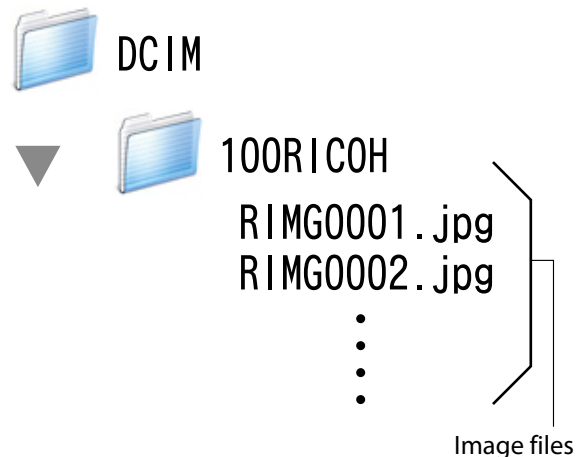

Caution

If you connect the camera or a card reader to a computer and then directly display, edit or save SD memory card images on the computer, you may no longer be able to play back the images on the camera. Download the images to the computer before displaying, editing or saving them.

Terms

Card Reader

This is a device connected to a computer to read the contents of cards. In addition to the memory card adapter-type, there are card readers into which you can directly load an SD memory card.

Chapter 3

How to Use EC1

EC1 is an edit detection software program that allows you to check and view whether still images taken using the G700SE have been processed or edited.



Caution

In order to carry out edit detection using EC1, you must set [Edit Detection] to [On] in the camera's shooting setting menu before shooting and download the images to your computer.

Using the Edit Detection Function

You can only carry out edit detection using EC1 after setting [Edit Detection] to [On] on your camera, shooting still images, and downloading the images to your computer.

1. Set [Edit Detection] to [On] in the camera's shooting setting menu, and shoot still images.
2. Download the still images shot using your camera to your computer.
3. Select [Programs] (or [All Programs]) > [EC1] > [EC1] from the Windows [Start] menu.
4. From the EC1 Folder View, select the folder for the downloaded images.

The JPEG images in the selected folder will be loaded and the images will be displayed in Thumbnail View after loading is complete.

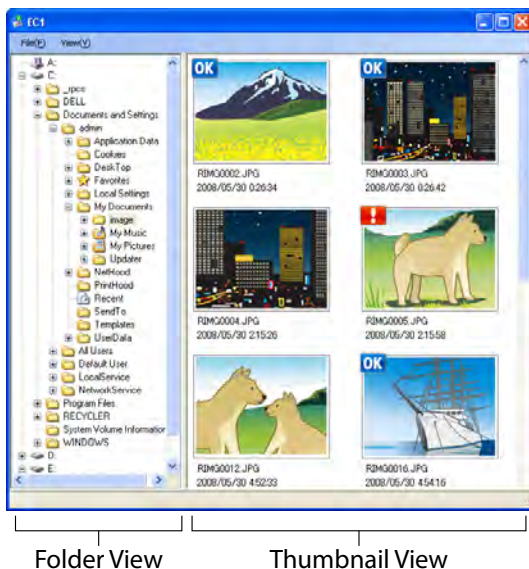

- **OK** is displayed with images that have not been processed or edited after shooting.
- **!** is displayed with images that have been processed or edited after shooting.

- Neither of the above icons is displayed with images taken when [Edit Detection] was set to [Off] or images for which edit detection is not possible.
- By double-clicking an image in the Thumbnail View, you can open the image using the linked viewer software.
- If a space occurs at the beginning or end of the folder name, a message will appear and no images will be displayed.

Caution

- Edit detection is available only with photographs taken using cameras equipped with an edit detection function.
- Images for which the [Resize], [Contrast Correction], or [Skew Correction] functions have been used during playback mode will be labeled as images that have been processed or edited.
- When downloading images to your computer, please use the method for downloading shown in Chapter 1. Images downloaded using different methods may be labeled as processed or edited images even if they have not been processed or edited. For example, when you download images to your computer using "Windows Photo Gallery" for Windows Vista or "Windows Live Photo Gallery" for Windows 7, a portion of the shooting data is edited during the download process. As a result, the images are labeled as processed or edited images for EC1.
- Depending on the software you used to view images after downloading them, the images may be labeled as processed or edited images if you viewed the images or image properties before saving or closing them.

Reference

- For details about how to install EC1, see the "Camera User Guide".
- For details about downloading images to your computer, see P.5.

Updating Folder Contents

After adding, deleting, or renaming folders, select [Reload] in the [View] menu to update the folder and thumbnail lists.

Chapter 4

Shooting with Camera Memos

You can attach camera memos (information such as shooting conditions) to the still images you shoot. This section explains camera memos.



Caution

- Be sure to set the date and time on the camera.
- To use the camera memo function, DC Software must be installed.
- Memos are not available with SD WORM memory cards.
- The camera memo function is only for use with Windows.



Note

Use ME1 to view and edit the memos that have been appended to photographs (👉 P.40).

Section 1

About Camera Memos

Shooting with Camera Memos

The image file storing the image shot with a digital camera has an area where additional information can be stored. The camera memo function uses this area to allow you to attach a memo to the still image you shoot.

Memos make photographs easy to identify and classify.

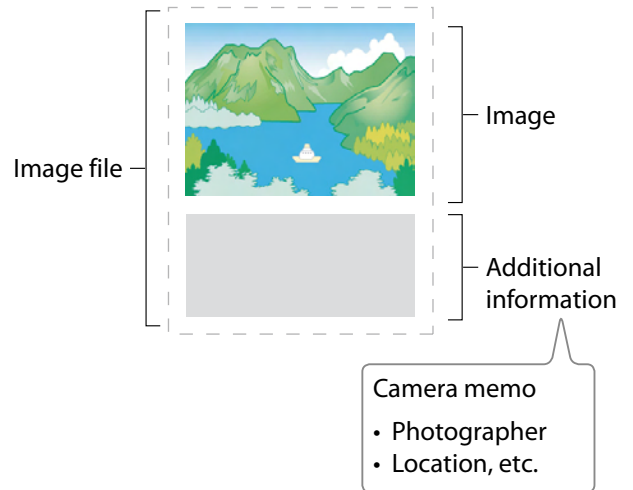

Note

- Memos can not be added to movies.
- Memos can not be added to photographs taken with [On] or [WB-BKT] selected for [Auto Bracket] in the camera shooting menu.

Memos

Memos consist of a list of “items” (tags), each with its own “description” (contents). Memos can be added to photographs by pressing the ADJ./MEMO button and selecting the desired descriptions in the camera memo dialog before shooting.

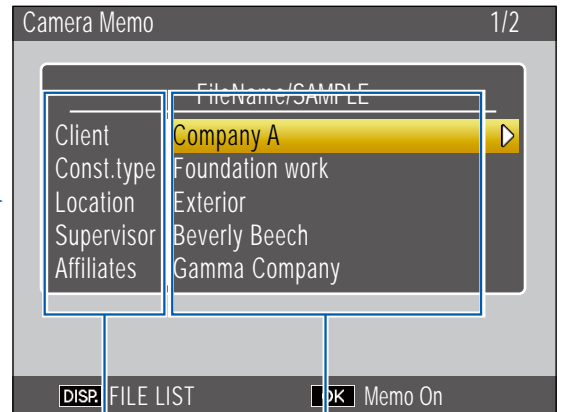

Items

Description

Using Memos





1. Create a memo list on the computer and transfer it to the camera (👉 P.23).

Use the supplied List Editor application to create and transfer to the camera a memo list file (extension ".mta") containing memo item names and descriptions.

2. Take photographs with memos (👉 P.27).

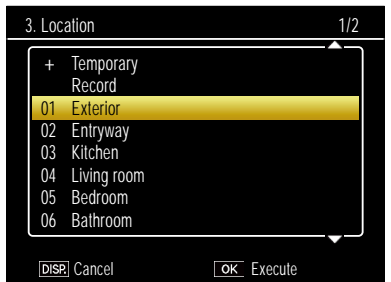
Press the ADJ./MEMO button to display the camera memo dialog (👉 P.27). After choosing descriptions, press MENU/OK to create a memo which will be added to all new photographs (if desired, the contents of the memo can be changed after shooting; 👉 P.29).

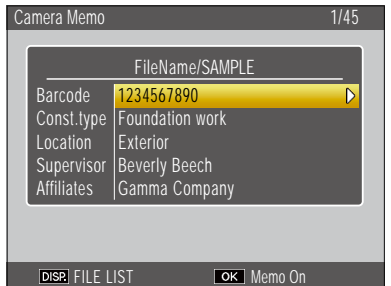
The following types of memo are available:

<p>1 Text (👉 P.23)</p> <p>Choose from up to 99 text descriptions created with the List Editor.</p>	
<p>2 Temporary memo (👉 P.30)</p> <p>Use the camera to create a temporary memo using descriptions not included in the memo list. The new descriptions are not stored in the memo list after the camera is turned off.</p>	
<p>3 Voice memos (👉 P.33)</p> <p>Record voice memos of up to 30 seconds in length.</p>	
<p>4 Barcodes (👉 P.36)</p> <p>Create temporary memos using text descriptions from barcodes read using the camera.</p>	
<p>5 Images (👉 P.38)</p> <p>To use still images as reference images, include a description with an image file name when creating the memo list. Note that the image file must first be copied to the camera memory card or internal memory.</p>	

3. Transfer the photos to the computer (👉 P.5).

Copy the photos to the computer using the supplied DL-10 software.

4. View and edit memos (👉 P.40).

Use the supplied ME1 software to display photographs, view and edit memos, and play voice memos.

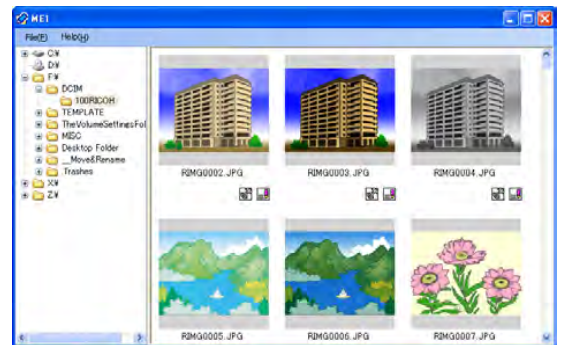

Note

- Memos will be added to all photographs taken while a memo list file is present in the camera's internal memory or on the memory card inserted in the camera.
- For information on installing the supplied software, see the "Software User Guide".
- The supplied software is available for Windows only.

Section 2

Creating and Transferring a Memo List

Creating a Camera Memo List

To create a camera memo list, use the provided software List Editor.

To create a memo list, first create a list of up to 20 items and then create up to 99 descriptions for each item.

Note

- A camera memo list file in CSV format created by a different application can be read into the List Editor and saved on an SD memory card for use by the camera.
- To read a csv format camera memo list file into List Editor, select [Open] from the [File] menu of List Editor, and then specify the file name.

Starting and Exiting List Editor

Starting List Editor

On the Windows [Start] menu, select [All Programs] or [Programs] then [Caplio Software] then [List Editor] to start List Editor.

Exiting List Editor

You can exit List Editor by clicking the [X] (Close) button in the upper-right corner of the window or by selecting [Exit] from the [File] menu.

The List Editor Dialog

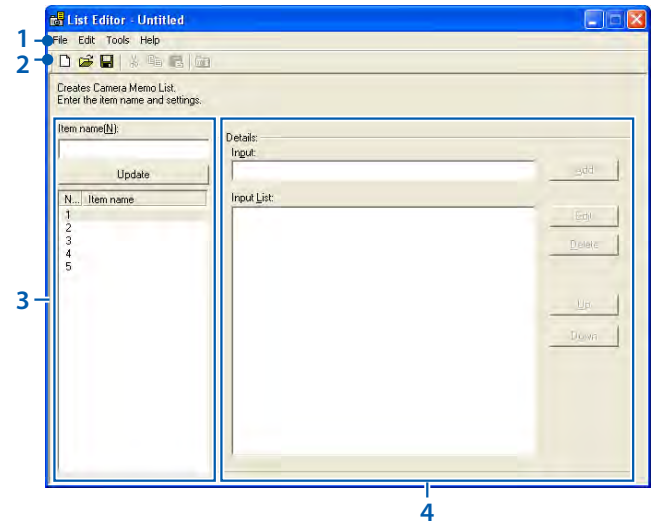

Item	Description
1	Menu bar Operations that can be performed using the menus include saving, editing, and transferring memo lists.
2	Toolbar Click the icons in the toolbar for quick access to the following menu items: <ul style="list-style-type: none"> • [New]: Open a dialog where you can create a new memo list. • [Open]: Open a memo list that you previously saved on the computer. • [Save]: Save the memo list to the computer. • [Cut]/ [Copy]/ [Paste]: Cut, copy, or paste selected text. • [Transfer to Camera]: Copy the memo list file to the [TEMPLATE] folder in the camera's internal memory or on the memory card currently inserted in the camera.
3	Item name (P.24) Name items in the memo list. The number of items can be selected from 20, 10, and 5 using the [Number of Items] option in the [File] menu.
4	Details (P.24) Enter descriptions for the selected item.

Using the List Editor

The List Editor is used to create a memo list containing up to 20 items with up to 99 descriptions for each item.

1. Choose the number of items in the memo list.

Select [Number of Items] from the [File] menu.

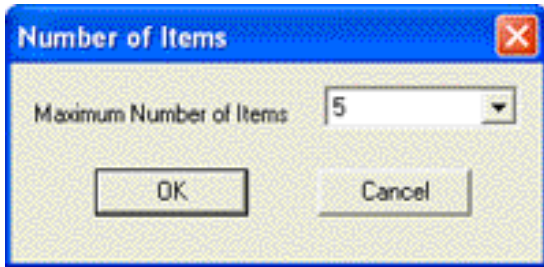

Choose the number of items from [5] (the default setting), [10], and [20]. If desired, the number of items can be changed after the memo list is created; note, however, that if the list contains more items than the new maximum, the excess items will be deleted.

2. Enter item names.

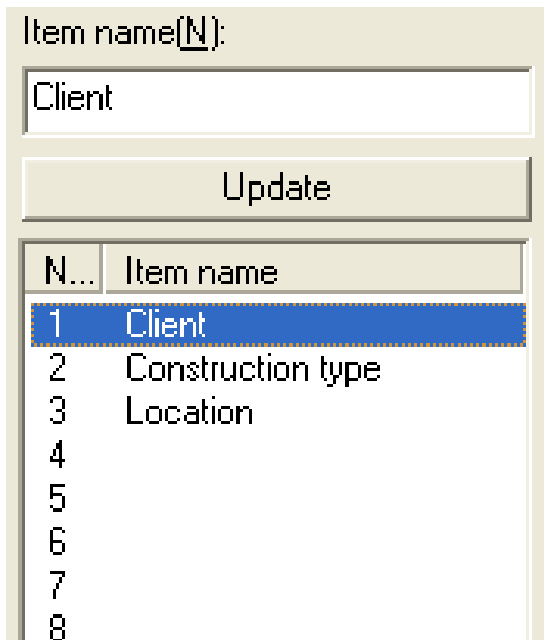

Click an item number, enter a name in the [Item name] text box, and click [Update] to display the new name in the item list. Follow the same procedure to change existing item names.

Caution

Item names can be up to 20 characters long. The following characters can not be used: \ / : ? * " < > |. Note that the presence of any of these characters, commas, or multiple periods may corrupt the display of item names in Russian-language operating systems.

3. Enter descriptions.

Select a name in the item list and edit the descriptions for the selected item.



Enter descriptions in the [Input] text box, and click [Add] to add them to the end of the input list. Changes to existing descriptions can be made by clicking the description and then clicking one of the following buttons:

- [Edit]: Edit the selected description.
- [Delete]: Delete the selected description.
- [Up]/[Down]: Move the selected description up or down in the input list.

Caution

Descriptions can be up to 32 characters long. The following characters can not be used: \ / : ? * " < > |. Note that the presence of any of these characters, commas, or multiple periods may corrupt the display of descriptions in Russian-language operating systems.

4. Complete the memo list.

Repeat Steps 2 and 3 to complete the memo list.

5. Save the memo list.

Select [Save As] in the [File] menu (memo lists can also be saved by clicking the  button in the toolbar).

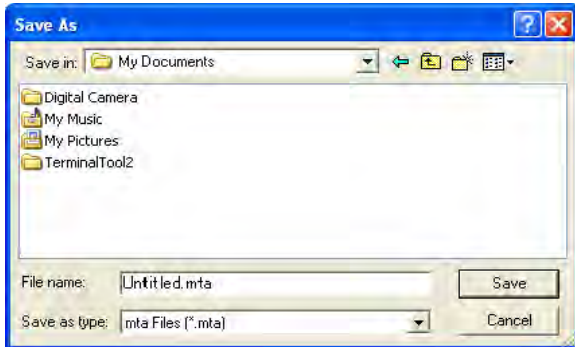

Confirm that [mta Files (*.mta)] is selected for [Save as type] (memo lists can be saved as CSV files, but the mta format must be used for memo lists intended for transfer to the camera). After navigating to the desired location and entering a file name of up to eight characters, click [Save] to save the memo list. Note that the camera can display only file names consisting entirely of unaccented (low ASCII) roman characters.

Although lists can be transferred directly to the camera without being saved, we recommend that you save the file before transfer.



Note

To edit an existing memo list, open it using the [Open] option in the [File] menu. After editing the list, save it using the [Save] option in the [File] menu or by clicking the  button in the toolbar.

Transferring a Memo List File to the Camera

Memo list files can be transferred to the camera from the List Editor or using a card reader.

The List Editor

1. Start the List Editor and connect the camera.

After starting the List Editor, connect the camera as described on P.6. Exit DL-10 if it starts when the camera is connected (☞ P.9).

2. Transfer the memo list file.

Click the [📷 Transfer to Camera] icon in the toolbar or select [Transfer to Camera] in the [Tools] menu. If a memory card is inserted in the camera, the file will be transferred to the [TEMPLATE] folder on the memory card; otherwise, it will be transferred to the [TEMPLATE] folder in internal memory.

! Caution

The file will only be transferred if the destination device contains a [TEMPLATE] folder. If the destination is a memory card, be sure it has been formatted in the camera.

3. Click [OK].

4. Exit the List Editor.

Select [Exit] from the [File] menu or click the close box [X] at the top right corner of the List Editor window.

5. Disconnect the camera.

Remove the camera from the system and disconnect the USB cable as described on P.9 (note that if the connection is not terminated normally, the memo list file may not be transferred to the camera). The memo list will be available for use when the camera is turned on.

Card Readers

A card reader can be used to copy a memo list file directly to the camera from the computer. Copy the file to the [TEMPLATE] folder on the memory card. A [TEMPLATE] folder is created automatically when a card is formatted in the camera.

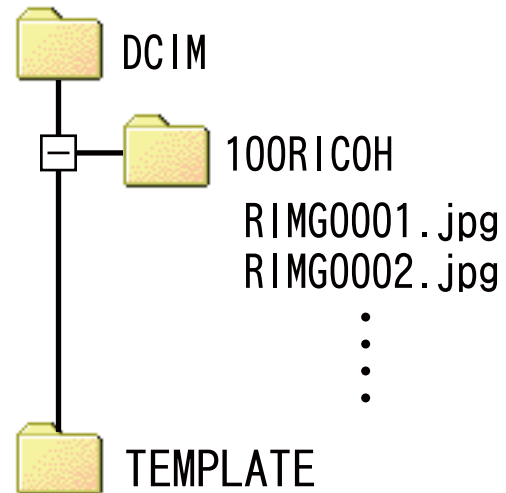

Deleting Memo List Files From Memory Cards

To prevent memos from being added to photographs, use a computer to delete all "*.mta" files from the [TEMPLATE] folder on the memory card or in the camera's internal memory. Memo list files can not be deleted by formatting the memory card or internal memory using the format option in the camera setup menu.

Section 3

Taking Photographs with Memos

Recording Memos with Photographs

Before proceeding, confirm that a memo list file has been transferred to the camera's internal memory or to the memory card inserted in the camera.

Adding Memos to New Photos

1. Select /CAL mode and press ADJ./MEMO.

The camera memo dialog will be displayed.

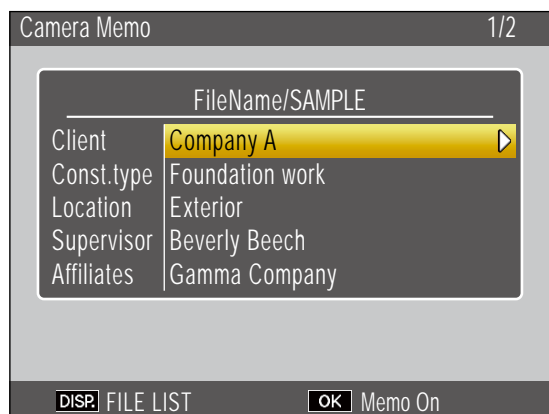

If the camera contains multiple memo list files, the most recently-used file will be displayed.

While the camera memo dialog is displayed, photos can still be taken by pressing the shutter-release button.

2. Create a memo.

Choose descriptions as described on P.28.

3. Press MENU/OK.

Press MENU/OK to accept the current memo.

4. Take photographs.

The memo will be added to all new photos.

Multiple Memo List Files

If the camera contains more than one memo list file, press DISP. to display a list of files. Press ▲ or ▼ to highlight a file and press MENU/OK to select.

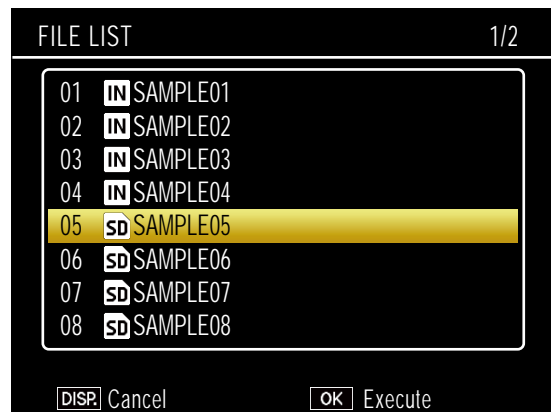

Note

- If [On] is selected for [Display Memo at Startup] in the camera memo menu, the camera memo dialog will be displayed automatically at camera startup.
- Memos will be added to all photographs taken while a memo list file is present on the camera. To prevent memos from being added to photographs, use a computer to delete all "*.mta" files from the [TEMPLATE] folder on the memory card or in the camera's internal memory. Memo list files can not be deleted by formatting the memory card or internal memory using the format option in the camera setup menu.
- Note that the camera can display only file names consisting entirely of unaccented (low ASCII) roman characters.

Choosing Descriptions

Descriptions can be selected in the camera memo dialog. The method used depends on the option selected for [Camera Memo Mode] in the camera memo menu.

[Mode1]

1. Highlight an item.

Press ▲ or ▼ to highlight an item.

2. View descriptions.

Press ► to view descriptions for the highlighted item.



3. Choose a description.

Press ▲ or ▼ to highlight a description and press MENU/OK to select.

4. Complete the memo.

Repeat Steps 1–3 to choose descriptions for the remaining items.

Note

- The last option in the list of descriptions is [No Setting]. Select this option to set the description for the current item to [No Setting]. Note however that if [On] is selected for [Memo Warning], a warning will be displayed and the shutter release will be disabled if you attempt to take a photograph with the description for one or more memo items set to [No Setting]. The shutter release can be enabled by choosing a description for the affected items.
- If [On] is selected for [Camera Memo 1 Auto Delete], the description for the first memo item will automatically be set to [No Setting] when the camera is turned on, a photograph is taken, or a memo list is transferred to the camera. The shutter release can be enabled by choosing a description for the first item.

[Mode2]

When the camera memo dialog is first displayed, the description for each item will be set to the first entry in that item's description list. Press ► once to set the description for each item to the second entry in the description list, twice to set the description for each item to the third entry in the description list, and so on. Press ◀ to return to the previous set of descriptions.

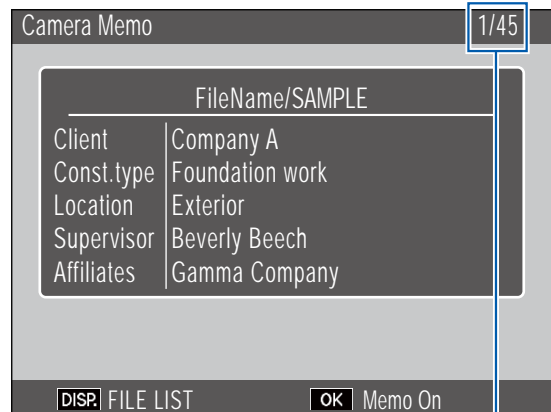

Shows the position of the current memo and the total number of combinations available. In this example, the current memo uses the first combination.

Press ▲ or ▼ to choose the item displayed. The descriptions for individual items can not be selected separately.

Note

To skip to the previous or next combination that contains a unique description for the item selected for [Memo Skip] in the camera memo menu, press and hold ◀ or ►. The following table gives an example of the combinations that would be skipped when [Item 1] is selected.

Item	Description 1	Description 2	Description 3	Description 4
1	A	A	A	B

The item used for [Memo Skip] can be selected from items 1–5.

Viewing Memos

Follow the steps below to view and edit photos that have been added to photographs.

Caution

- Memos can not be deleted.
- Camera memos can only be edited as described below when [Mode1] is selected for [Camera Memo Mode] in the camera memo menu. In Mode2, memos can be displayed by pressing DISP. during playback but can not be edited.

Viewing Memos

1. Display the desired photo in playback mode.

Photographs to which memos have been added are indicated by a "MEMO" icon.

2. Press ADJ./MEMO.

The memo will be displayed as shown below. Press ▲ or ▼ to view additional data.

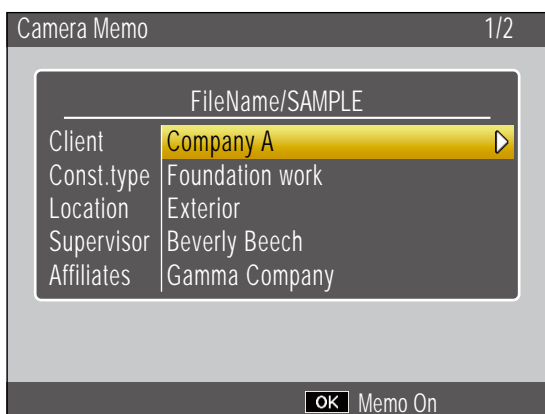

3. Press MENU/OK.

Press MENU/OK to return to normal playback.

Editing Memos

1. Display the desired photo in playback mode.

Photographs to which memos have been added are indicated by a "MEMO" icon.

2. Press ADJ./MEMO.

The memo will be displayed as shown below.

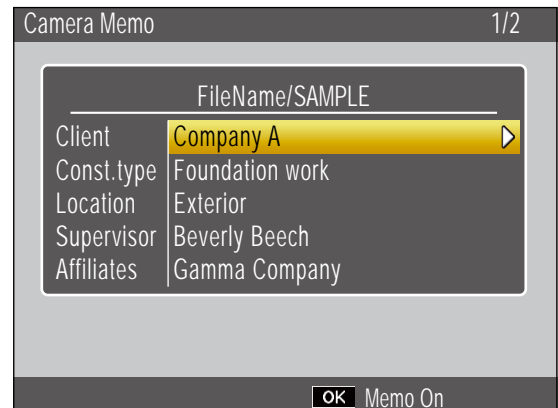

3. Select an item.

Press ▲ or ▼ to highlight an item and press ► to view descriptions for the highlighted item.



4. Choose a description.

Press ▲ or ▼ to highlight a description and press MENU/OK to select.

5. Press MENU/OK.

Press MENU/OK to return to normal playback.

Creating a Temporary Memo

Memo descriptions can be created on the camera (either by editing existing descriptions or creating entirely new descriptions) and the resulting “temporary memo” appended to new photos. Temporary memos can be created in both shooting and playback mode.

Note

- Temporary memos are not stored in the memo list after the camera is turned off.
- Temporary memos can be created using barcodes (P.36).
- Temporary memos are available only when [Mode1] is selected for [Camera Memo Mode] in the camera memo menu.

Creating a Temporary Memo

To create a temporary memo, display the camera memo dialog and follow the steps below.

1. Select an item.

Press ▲ or ▼ to highlight an item and press ► to view descriptions for the highlighted item.

2. Select [Temporary].

Press ▲ or ▼ to highlight [Temporary] and press MENU/OK.



3. Select [Yes].

Press ◀ or ▶ to highlight [Yes] and press MENU/OK.



4. Create a temporary description.

An on-screen keyboard will be displayed. Use the keyboard to enter a temporary description as described on P.49.

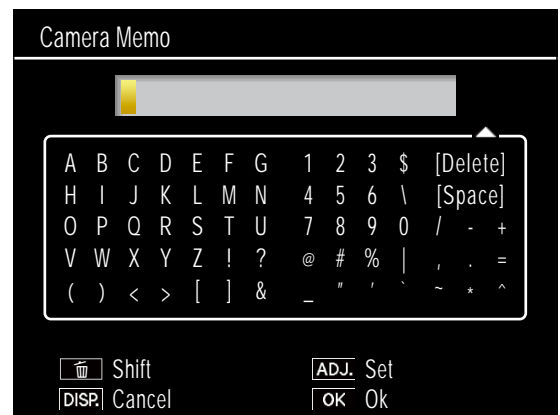

After entering the description, press ADJ./MEMO to return to the description list.

5. Select the temporary description.

Press ▲ and ▼ to highlight the temporary description and press MENU/OK to select (to exit without saving the temporary description and restore the description previously selected, press DISP.). Repeat Steps 1–4 to create additional temporary descriptions as desired.

Editing the Temporary Memo

1. Select an item.

In the camera memo dialog, press ▲ or ▼ to highlight an item for which you have created a temporary description and press ► to view descriptions for the highlighted item.

2. Select a temporary description.

Temporary descriptions are indicated by a "+". Press ▲ or ▼ to highlight a temporary description and press ►.



3. Edit the description.

Edit the description as described in Steps 3–5 of "Creating a Temporary Memo."

Creating a Temporary Memo from an Existing Memo

Create a temporary memo by editing an existing memo.

1. Select an item.

Press ▲ or ▼ to highlight an item in the camera memo dialog and press ► to view descriptions for the highlighted item.

2. Select a description.

Press ▲ or ▼ to highlight a description and press ►.



3. Edit the description.

Edit the description as described in Steps 3–5 of "Creating a Temporary Memo."



Note

Edited descriptions are stored as a temporary memo. The original descriptions are not affected.

Memo Increment

If a memo description ends in a number, you can increase or decrease the number by pressing ▲ or ▼.

Caution

Memo increment is available only when [Mode1] is selected for [Camera Memo Mode] in the camera memo menu.

Using Memo Increment

Transfer to the camera a memo list file containing descriptions that end in numbers and follow the steps below.

1. Select [On] for [Memo Increment].

Select [On] for [Memo Increment] in the camera memo menu.

2. Select an item.

Press ▲ or ▼ to highlight an item in the camera memo dialog and press ► to view descriptions for the highlighted item.

3. Select a description that ends in a number.

Press ▲ or ▼ to highlight a description that ends in a number and press ► to display the memo increment dialog.

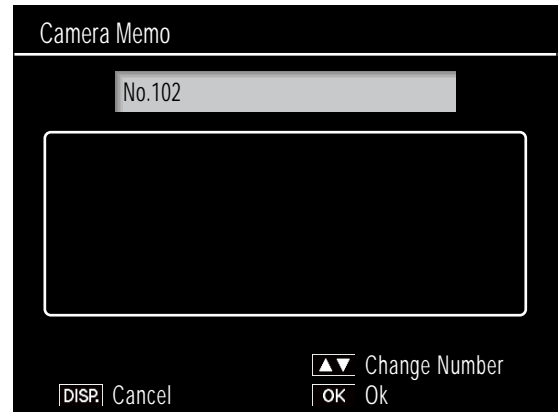

A warning will sound if you select a description that does not end in a number.

4. Edit the number.

Press ▲ or ▼ to choose a new number and press MENU/OK twice to return to shooting mode. The new number will be recorded with the next photograph taken.

Note

The new number is stored as a temporary memo. The original description is not affected.

Using Memo Increment with Temporary Memos

Memo increment can be used with temporary memos.

- 1. Create a temporary description that ends in a number (☞ P.30).**
- 2. Select [On] for [Memo Increment].**
Select [On] for [Memo Increment] in the camera memo menu.
- 3. Select the item.**
In the camera memo dialog, press ▲ or ▼ to highlight the item with the temporary description you created in Step 1 and press ► to view descriptions for the highlighted item.
- 4. Select the temporary description.**
Temporary descriptions are indicated by a "+". Press ▲ or ▼ to highlight the description and press ► to display the memo increment dialog.

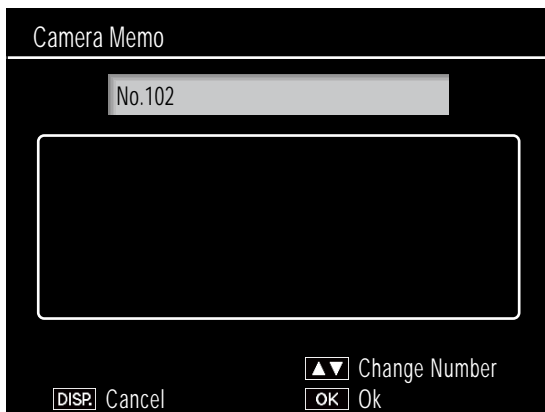

- 5. Edit the number.**
Press ▲ or ▼ to choose a new number and press MENU/OK twice to return to shooting mode. The new number will be recorded with the next photograph taken.

Voice Memos

Each item in a memo can have as a description an audio recording of up to 30 seconds in length. Voice memos can be created and edited in both shooting and playback mode.

Note

- Voice recordings are deleted from the memo list when the camera is turned off. Voice recordings already stored in memos that have been appended to photos are not affected.
- Voice memos can be played back on the computer when photographs are displayed in the supplied ME1 software.

Recording Voice Memos

- 1. Select an item.**
Press ▲ or ▼ to highlight an item in the camera memo dialog and press ► to view descriptions for the highlighted item.
- 2. Select [Record].**
Press ▲ or ▼ to highlight [Record] and press MENU/OK to display the recording dialog.

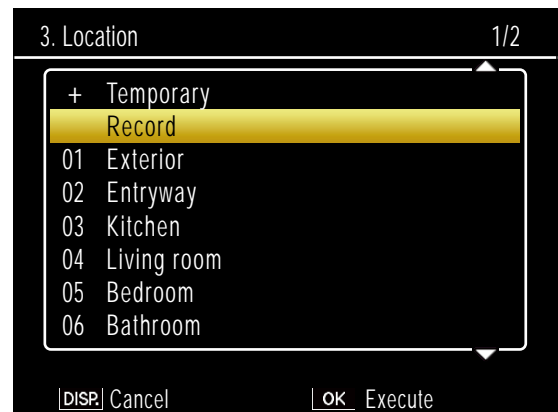

3. Record a voice memo.

Press the shutter-release button to begin recording.

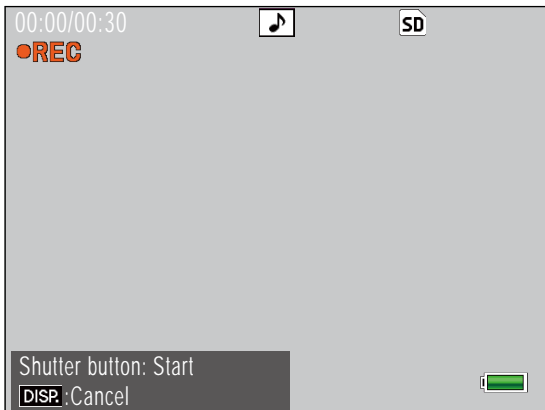

Recording ends after 30 seconds or when the shutter-release button is pressed halfway. The description list will be displayed with a ► icon next to the [Record] option (in playback mode, [Record] changes to [Playback]).



4. Press MENU/OK.

Items for which a recording exists are indicated by a ► icon in the camera memo dialog.

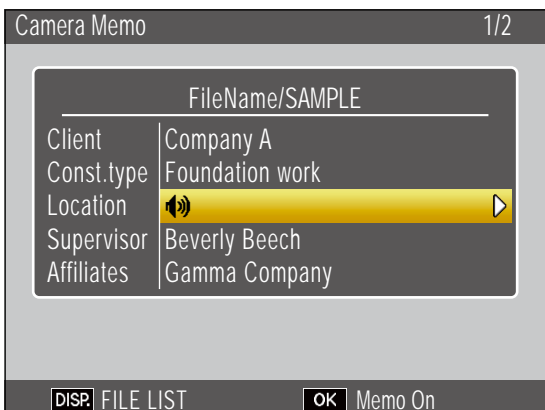

Note

- Do not obstruct the microphone during recording. Keep microphone within 20 cm (7.8 in.) of the source.
- Voice memos are not available with matrix barcodes. The [Record] option is not displayed in the description list when a matrix barcode type is selected.

Playing Voice Memos

Voice memos can only be played back in playback mode.

1. Select an item for which a recording exists.

In the camera memo dialog, press ▲ or ▼ to highlight an item marked with a ► icon and press ► to view descriptions for the highlighted item.

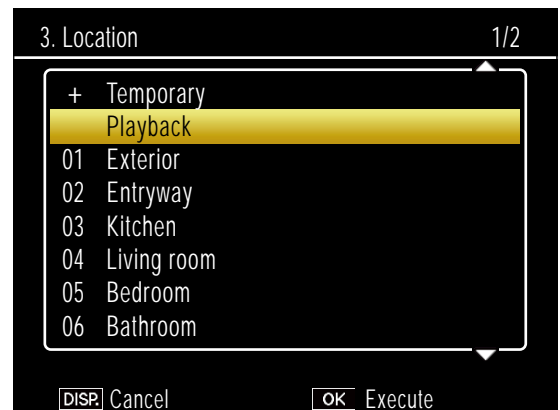

2. Select [Playback].

Press ▲ or ▼ to highlight [Playback] and press ► to display the playback dialog.



3. Play the recording.

Press the shutter-release button to play the recording.

Playback ends when the end of the recording is reached or when the shutter-release button is pressed halfway. A confirmation dialog will be displayed.

To re-record the memo as described in Step 3 of "Recording Voice Memos," press ◀ or ▶ to highlight [Yes] and press MENU/OK. Select [No] to return to the description list without modifying the recording.

Re-recording Voice Memos

Follow the steps below to edit voice memos in shooting mode.

1. Select an item for which a recording exists.

In the camera memo dialog, press ▲ or ▼ to highlight an item for which a recording exists and press ▶ to view descriptions for the highlighted item.



2. Select [Record].

Press ▲ or ▼ to highlight [Record] and press ▶ to display the recording dialog.

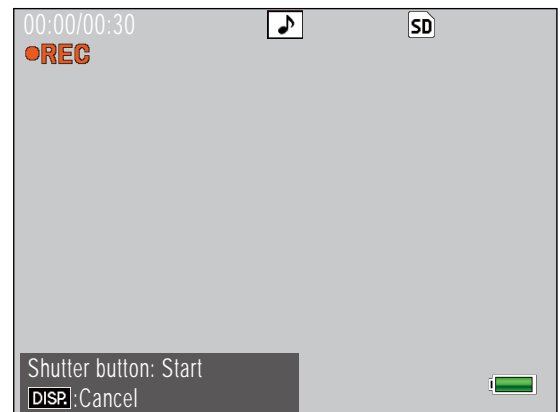

Re-record the voice memo as described in Step 3 of "Recording Voice Memos."

Registering Barcode Data as a Temporary Memo

The camera can read barcodes and store the data as temporary descriptions for temporary memos. Barcodes can be read in both shooting and playback mode.

Note

- The camera can read linear barcodes of up to 32 digits and matrix barcodes of up to 2400 digits. The barcode type can be selected using the [Barcode Type] option in the camera memo menu.
- Voice memos are not available with matrix barcodes. The [Record] option is not displayed in the description list when a matrix barcode type is selected.

Choosing a Barcode Mode

The [Barcode Mode] option in the camera memo menu can be used to choose where barcode data are stored.

Mode1	The barcode is stored in the memo list as a temporary description for the first item. This description is overwritten each time a barcode is read.
Mode2	The first barcode read is stored in the memo list as a temporary description for the first item, the second barcode as a temporary description for the second item, the third barcode as a temporary description for the third item, and the fourth barcode as a temporary description for the fourth item. These descriptions are overwritten in turn as new barcodes are read.
Mode3	This option only takes effect in shooting mode. Up to fifty barcodes can be stored in the memo list as temporary descriptions for the first item. These data can be viewed in the camera memo dialog before shooting but can not be changed and are deleted after a photograph is taken.

Reading a Barcode and Registering Barcode Data

Shooting Mode

1. Press the ADJ./MEMO button.
The [Camera Memo] screen appears.
2. Point the camera toward the barcode you want to read and press the ◀ button.

The camera switches to macro mode and reads the barcode data. When the camera finishes reading the barcode, the data are stored as a temporary description for the first item in the memo.

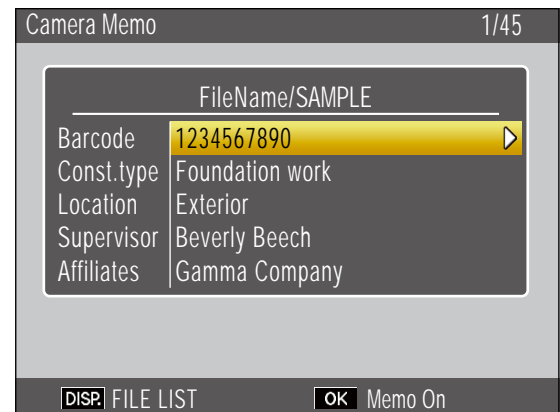

If the camera is unable to read the barcode or if you wish to exit without reading the barcode, press ▶ or DISP. to return to the camera memo dialog. Press ◀ to read the barcode again.

Non-ASCII characters in the barcode data will be replaced by asterisks ("*").

3. Read additional barcodes.

If [Mode2] or [Mode3] is selected for [Barcode Mode], repeat Step 2 to read additional barcodes.

4. Press MENU/OK to accept the new memo.

The new memo will be recorded with the next photograph taken.

To delete barcodes read with [Mode3] selected for [Barcode Mode], highlight the first item in the camera memo dialog and press ► to display the description list. Press ▲ or ▼ to highlight [No Setting] and press MENU/OK.

Playback Mode

1. Display a photograph.

Display a photograph to which you wish to add barcode data.

2. Press the ADJ./MEMO button.

The [Camera Memo] screen appears.

3. Press the ◀ button.

You can now read barcode data.

4. Point the camera toward the barcode you want to read and press the ◀ button.

The camera switches to macro mode and reads the barcode data. When the camera finishes reading the barcode, the data are stored as a temporary description for the first item in the memo.

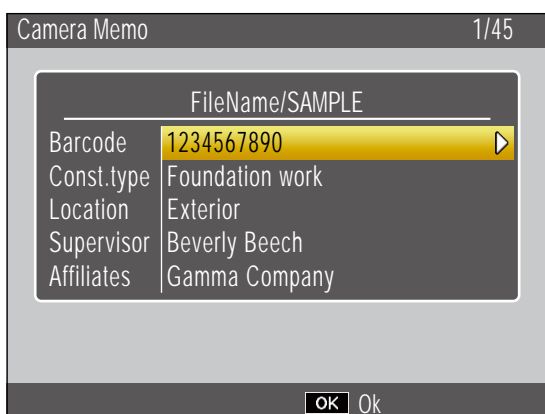

If the camera is unable to read the barcode or if you wish to exit without reading the barcode, press ► or DISP. to return to the camera memo dialog. Press ◀ to read the barcode again.

Non-ASCII characters in the barcode data will be replaced by asterisks ("*").

5. When [Barcode Mode] is set to [Mode2], you can repeat Step 4 and read additional barcodes.

6. Press the MENU/OK button to confirm the camera memo.

7. Press the MENU/OK button.

The memo will be added to the photograph.



Caution

- You cannot read the same barcode more than once.
- If, after reading the barcode, you shoot a picture or change modes and then read another barcode, the previously registered barcode data is overwritten.
- If you edited the camera memo before reading a barcode, the changes to the camera memo are not retained if the camera is unable to read the barcode. However, voice memos are retained.



Note

- You can edit the barcode data registered as a temporary memo. (▶ P.31)
- The time available to read barcodes can be selected using the [Scan Time] option in the camera memo menu.

Image Memos

To use still images as memos, include a description with an image file name when creating the memo list. Note that the image file must first be copied to the camera memory card or internal memory.

Caution

Image memos can be viewed only when [Mode2] is selected for [Camera Memo Mode] in the camera memo menu. No image will be displayed if a file with the selected name can not be found.

First Steps

1. Enter the image file name as a description.

Using the supplied List Editor application, enter the file name of the desired image as a description for the last item in the item list (P.23).

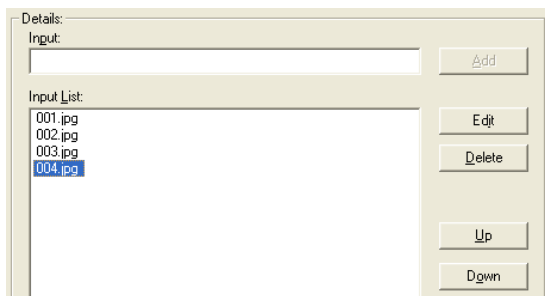

Caution

- Enter the file name as the description for the last item in the item list. The image will not be displayed if the file name is entered as a description for other items in the list.
- Image memo file names must end in the ".jpg" extension.

2. Connect the camera to the computer.

See "Downloading Images Without Using DL-10" (P.6) for more information.

3. Copy the image to the camera.

Copy the image to the [TEMPLATE] folder in internal memory or on the camera memory card.

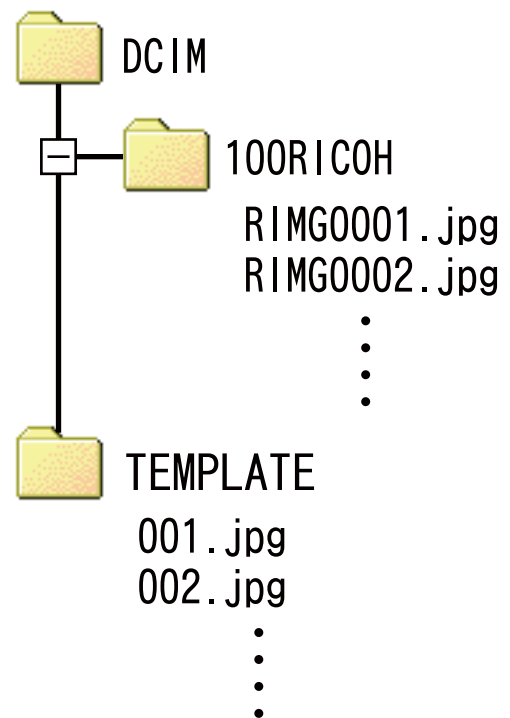

Note

Image memos must satisfy all the following criteria:

- **File type:** JPEG
- **Color space:** YCbCr 4:2:2 or 4:2:0
- **Dimensions (W × H):** From 32 × 32 to 4000 × 3000 pixels, where the width is a multiple of 16 and the height a multiple of 8 (YCbCr 4:2:2) or 16 (YCbCr 4:2:0)
- **File size:** 12 MB or less

Viewing Image Memos

Shooting Mode

To view image memos, press ADJ./MEMO in the camera memo dialog. Press ADJ./MEMO again to return to the camera memo dialog.

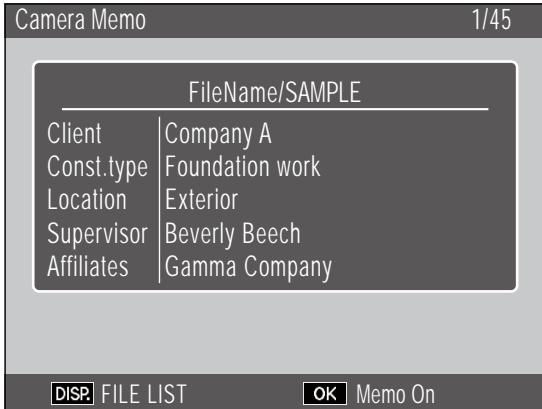



ADJ./MEMO button 

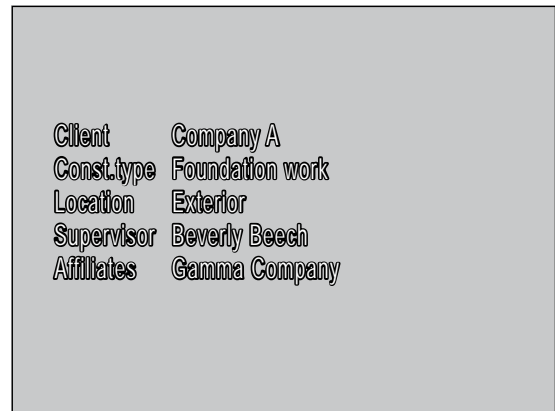

Playback Mode

To view an image memo that has been appended to a photograph, display the photograph and press ADJ./MEMO.



ADJ./MEMO button 



Press ▲, ▼, ◀, or ▶ to return to playback and display other photographs.

Caution

No image memo will be displayed if a file with the selected name can not be found.

Section 4

Viewing/Editing a Camera Memo on a Computer



Using ME1

Once photographs have been transferred to the computer, the supplied ME1 software can be used to display photographs, view and edit memos, and play voice memos.

Select [Programs] (or [All Programs]) > [DC Software] > [ME1] from the Windows [Start] menu to start the software.

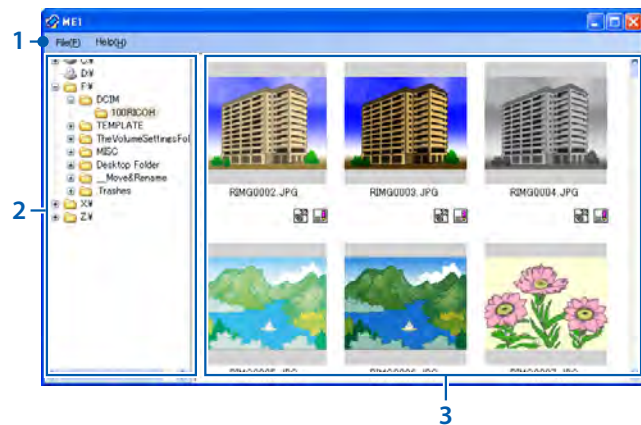
The ME1 Window



Item	Description
1	Menu bar Operations that can be performed using the menus include printing and viewing photographs.
2	Folder list A list of the folders on the computer. Click a folder to display any photographs it contains in the thumbnail list.
3	Thumbnail list A list of the photographs in the selected folder. Double-click a thumbnail to display the photograph full frame. The following icons are displayed under the photos in the thumbnail list: <ul style="list-style-type: none">  (GPS icon): Double-click this icon to display GPS data recorded with the photo. If no GPS data are recorded with the photo, this icon will be grayed out and unavailable.  (memo icon): Double-click this icon to edit the memo appended to the photo. If no memo has been added to the photo, this icon will be grayed out and unavailable.

Editing Memos

To edit the memo for a selected photo, double-click the  icon in the thumbnail list. The edit dialog will be displayed.

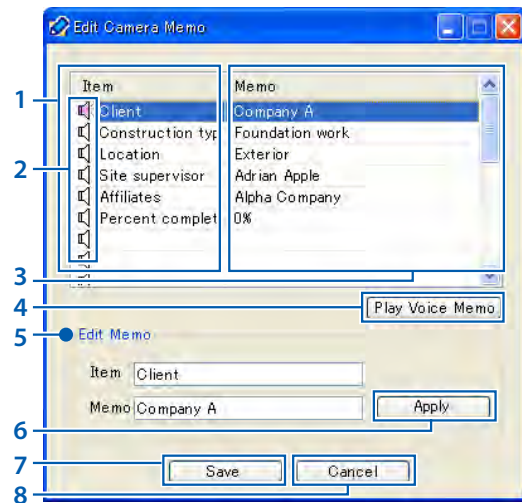

Item	Description
1	Item A list of the items in the memo.
2	Voice memo icons The icons for items that contain voice memos are displayed in red.
3	Memo The descriptions for the items in the item list.
4	[Play Voice Memo] button Click to play the voice memo for the selected item.
5	Edit Memo Lists the item name and description for the item selected in the item list. The name and description can be edited by typing in the corresponding text box (the following characters can not be used: \ / : ? * " < >).
6	[Apply] button Click to apply the changes in the [Edit Memo] panel.
7	[Save] button Save changes and close the edit dialog.
8	[Cancel] button Close the edit dialog. Any changes made since the last time you clicked the [Apply] button will be lost.

Caution

- No photographs will be displayed if a space occurs at the beginning or end of the folder name. Edit the folder name.
- Note that the presence of commas, multiple periods, or any of the following characters may corrupt the display of item names in Russian-language operating systems: \ / : ? * " < > |

Printing Memos with Photographs

Select [Print] in the [File] menu to print memos with photographs. Printer settings can be adjusted by selecting [Settings] in the [File] menu.

Print Samples

Single photo printed with memo on an A4 sheet

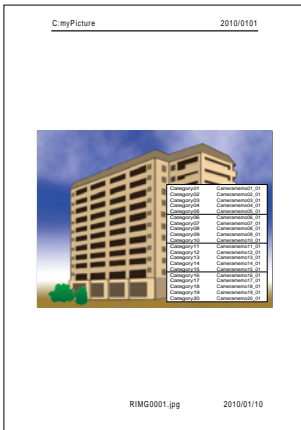

Two photos printed with memos on an A4 sheet

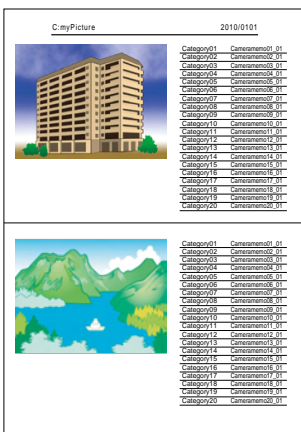

Three photos printed with memos on an A4 sheet

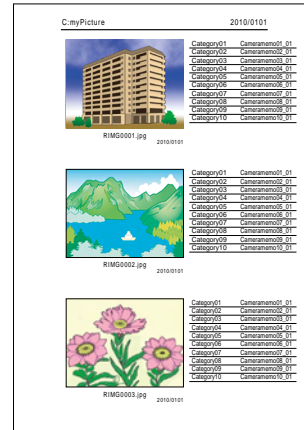

Note

- Photos can be printed without memos.
- The number of memo items that can be printed with three photos on a single sheet varies with printer settings.

Section 5

Using Memos to Sort Photos

Using EX1

The supplied EX1 software can be used to:

- Rename photographs or organize photographs into folders using memo data, allowing you to get an idea of memo contents from the image file names
- Export memos in CSV, XML, or TXT format

EX1 is available in client and server versions. The server version (“EX1 for Server”) continuously monitors a selected source folder for new images and automatically processes them as they are added to the folder. The client version (“EX1 for Client”) does not process images automatically.

EX1 Operation Flow

1. Copy photos to the computer (👉 P.5).

Copy photographs with memos to the computer, either using DL-10 or by another method.

2. Adjust transfer settings (👉 P.43).

Choose source and destination folders.

3. Process photographs.

The server version of EX1 automatically processes photos as they are added to the source folder (👉 P.45); to process photos using the client version, select [Programs] (or [All Programs]) > [EX1 for Client] > [Transfer] from the Windows [Start] menu (👉 P.45).

Starting and Exiting EX1

EX1 for Server

When installed using the default installation options, EX1 resides permanently in the system tray. To close EX1, click the icon in the system tray and select [Quit].

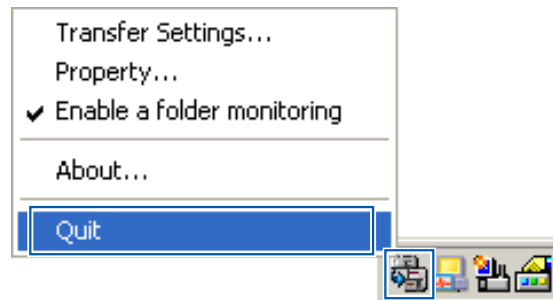

To restart EX1, select [Programs] (or [All Programs]) > [EX1 for Server] from the Windows [Start] menu.

EX1 for Client

To adjust settings, select [Programs] (or [All Programs]) > [EX1 for Client] > [Setting] from the Windows [Start] menu. To process photos, select [Programs] (or [All Programs]) > [EX1 for Client] > [Transfer]. To exit EX1, close the transfer settings dialog. EX1 will terminate automatically when processing is complete.

Transfer Settings

EX1 for Server

Clicking the EX1 icon in the system tray with the right mouse button displays the following transfer settings dialog.

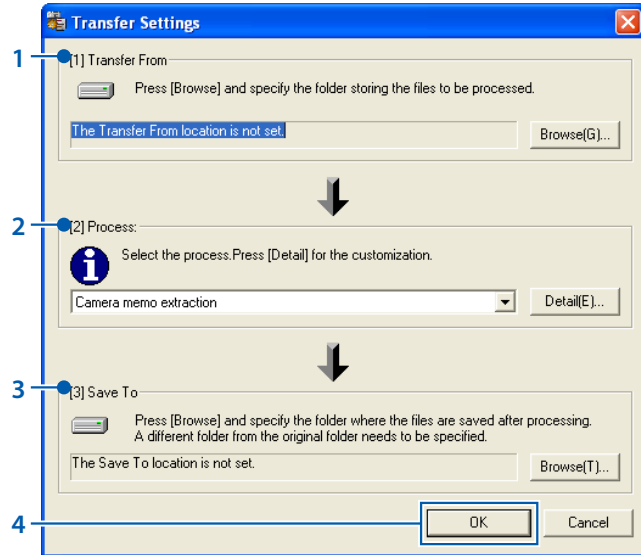

Item	Description
1	Transfer From Click [Browse...] to choose the watched folder.
2	Process Choose how photographs will be processed. <ul style="list-style-type: none"> • Camera memo extraction: Rename files according to memo contents and transfer them to the selected destination folder, or export memos in CSV, XML, or TXT format. • Camera memo category: Create sub-folders in the selected destination folder named according to memo contents and transfer files to the appropriate sub-folders. Click [Detail...] to adjust settings for the selected option (P.44).
3	Save To Click [Browse...] to choose a destination folder.
4	[OK] button Save changes and exit.

EX1 for Client

Select [Programs] (or [All Programs]) > [EX1 for Client] > [Setting] from the Windows [Start] menu.

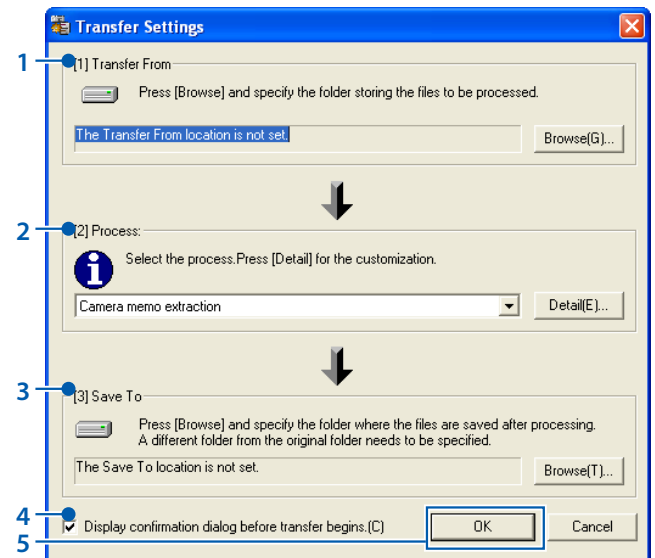

Item	Description
1	Transfer From Click [Browse...] to choose the folder containing the images you intend to process.
2	Process Choose how photographs will be processed as described under "EX1 for Server."
3	Save To Click [Browse...] to choose a destination folder.
4	[Display confirmation dialog before transfer begins] Select this option to display a confirmation dialog before transfer begins (P.45)
5	[OK] button Transfer photos. The original files will be deleted when transfer is complete. (The first time you start EX1 for Client, this button is displayed as [Begin Transfer].)

Note

If [Camera memo extraction] is selected for [Process], reserved characters (\ / : ? * " < > |) are automatically converted to underscores (" _ ") when memo item names and descriptions are used as folder names.

Process > Detail

Clicking [Detail...] in the [Process] panel displays the following dialog.

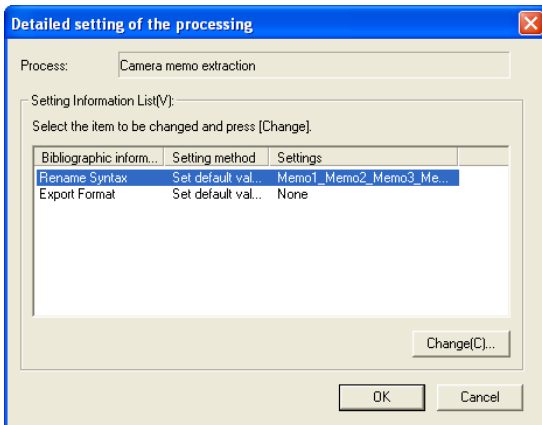

The items in the setting information list depend on the option selected in the [Process] panel. To change settings, highlight an item in the setting information list and click [Change...].

Camera Memo Extraction > Rename Syntax

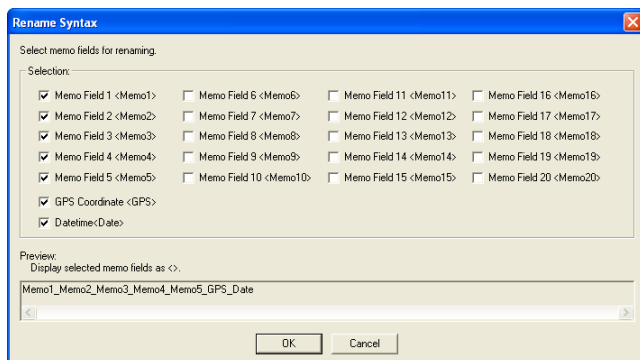

Choose the memo items that will be used to rename files. If multiple items are selected, they will be separated by an underscore (" _ ") in the file name.

Camera Memo Extraction > Export Format

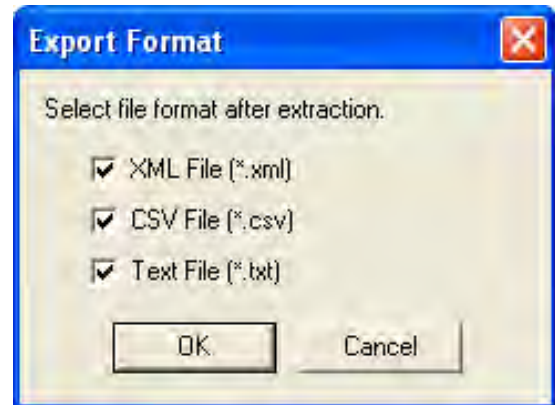

Select the format or formats that will be used to export memos. Memos will not be exported if no options are selected.

Camera memo category > Transfer Mode

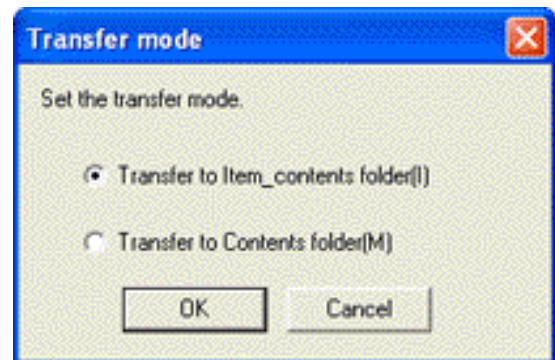

Choose whether folder names will consist of the item name and description separated by an underscore (" _ ") or simply the description.

Example: Given the following camera memo...

Item Name	Description
Item 1	Description A
Item 2	Description B
Item 3	Description C
Item 4	Description D

...the following folders will be created using the item names and descriptions:

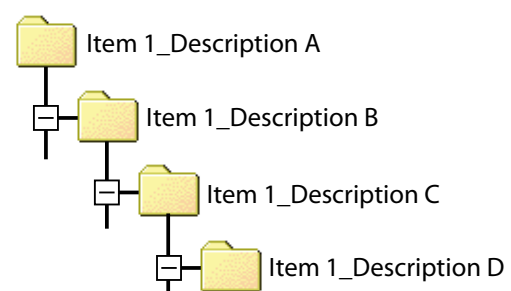

Processing Photos

EX1 for Server

If folder monitoring is enabled, EX1 will monitor the folder selected in the transfer settings dialog and automatically process images as they are added to the folder. Disable folder monitoring to prevent images from being processed automatically.

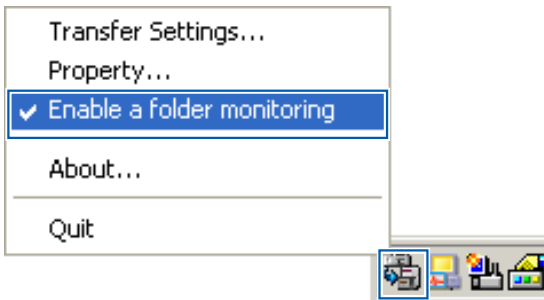

Caution

If a transferred file is found to be damaged or corrupt, a message will be displayed and transfer will end automatically.

EX1 for Client

Select [Programs] (or [All Programs]) > [EX1 for Client] > [Transfer] from the Windows [Start] menu. If [Display confirmation dialog before transfer begins] is selected in the transfer options dialog, the following dialog will be displayed. Click [Transfer] to transfer the images.

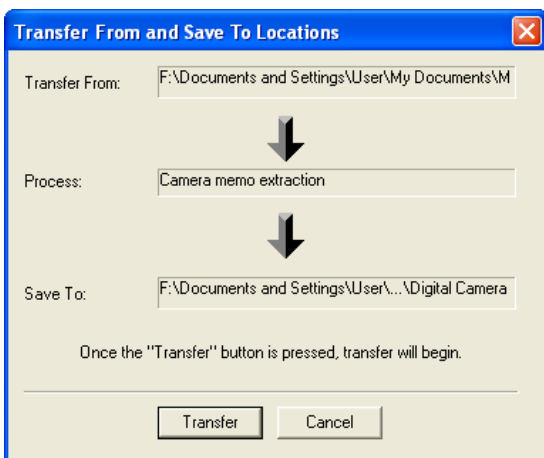

Note

The original files are deleted after transfer.

Property

To open the EX1 for Server properties dialog, right click the EX1 icon in the system tray.

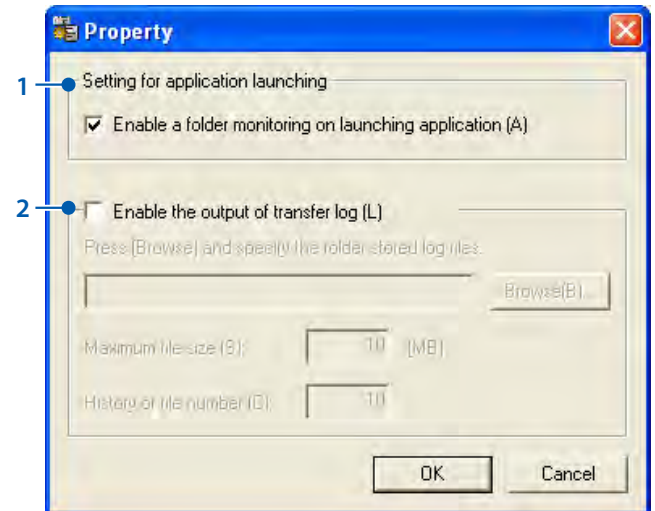

Item	Description
1	Setting for application launching Choose whether folder monitoring is enabled by default.
2	Enable the output of transfer log Choose whether a log file will be created when images are transferred. <ul style="list-style-type: none"> • Browse...: Choose a destination for the log file. • Maximum file size: Choose the maximum size for the log file. • History of file number: Choose the number of files included in the transfer history.

File Information

The information below is included in files created using [Export Format].

This example assumes that the following file is transferred:

File Description

Item	Content
Date of recording	2010.10.10 00:00:00
GPS data	None

Memo Contents

Item Name	Description
Item 1	Description A
Item 2	Description B
Item 3	Description C
Item 4	Description D
Item 5	Description E

XML Format

Main Tag Name	Content
DateTimeOriginal	Shooting date of the image file
GPSLatitudeRef	Latitude (N or S)
GPSLatitude	Latitude (Numeric value)
GPSLongitudeRef	Longitude (E or W)
GPSLongitude	Longitude (Numeric value)
CameraMemo1– CameraMemo5	Item names and descriptions
Memoltem1– Memoltem5	Item names
MemoData1– MemoData5	Descriptions

```
<?xml version="1.0" encoding="Shift_JIS"?>
<Exif>
  <APP1>
    <Exif_IFD>
      <DateTimeOriginal>2010:10:10 00:00:00
    </DateTimeOriginal>
    </Exif_IFD>
    <GPS_IFD>
      <GPSLatitudeRef>N</GPSLatitudeRef>
      <GPSLatitude>00:00:00</GPSLatitude>
      <GPSLongitudeRef>E</GPSLongitudeRef>
      <GPSLongitude>00:00:00</GPSLongitude>
    </GPS_IFD>
  </APP1>
  <APP5>
    <CameraMemo1>
      <Memoltem1>Item 1</Memoltem1>
      <MemoData1>Description A</MemoData1>
    </CameraMemo1>
    <CameraMemo2>
      <Memoltem2>Item 2</Memoltem2>
      <MemoData2>Description B</MemoData2>
    </CameraMemo2>
    <CameraMemo3>
      <Memoltem3>Item 3</Memoltem3>
      <MemoData3>Description C</MemoData3>
    </CameraMemo3>
    <CameraMemo4>
      <Memoltem4>Item 4</Memoltem4>
      <MemoData4>Description D</MemoData4>
    </CameraMemo4>
    <CameraMemo5>
      <Memoltem5>Item 5</Memoltem5>
      <MemoData5>Description E</MemoData5>
    </CameraMemo5>
  </APP5>
</Exif>
```

CSV Format

Main Tag Name	Content
DateTimeOriginal	Shooting date of the image file
GPSLatitudeRef	Latitude (N or S)
GPSLatitude	Latitude (Numeric value)
GPSLongitudeRef	Longitude (E or W)
GPSLatitude	Longitude (Numeric value)
(Memo item names and descriptions)	The above information is followed by the memo item names and descriptions.

DateTimeOriginal,2010:10:10 00:00:00

GPSLatitudeRef,N

GPSLatitude,00:00:00

GPSLongitudeRef,E

GPSLatitude,00:00:00

Item 1, Description A

Item 2, Description B

Item 3, Description C

Item 4, Description D

Item 5, Description E

TXT Format

Main Tag Name	Content
DateTimeOriginal	Shooting date of the image file
GPSLatitudeRef	Latitude (N or S)
GPSLatitude	Latitude (Numeric value)
GPSLongitudeRef	Longitude (E or W)
GPSLatitude	Longitude (Numeric value)
CameraMemo1– CameraMemo5	Memo item names and descriptions

[DateTimeOriginal]

2010:10:10 00:00:00

[GPSLatitudeRef]

N

[GPSLatitude]

00:00:00

[GPSLongitudeRef]

E

[GPSLatitude]

00:00:00

[CameraMemo1]

Item 1

Description A

[CameraMemo2]

Item 2

Description B

[CameraMemo3]

Item 3

Description C

[CameraMemo4]

Item 4

Description D

[CameraMemo5]

Item 5

Description E

Appendices

How to Use the Keyboard

To use the keyboard, follow the steps below.

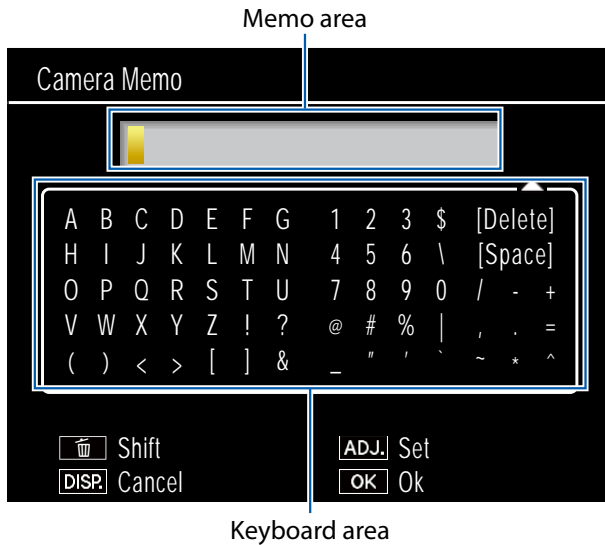

1. Enter a description of up to 32 characters.

Highlight characters using ▲, ▼, ◀, or ▶ and press MENU/OK to enter the highlighted character at the current cursor position (to delete the character at the current cursor position, select [Delete]). Press ⇧ to shift between upper and lower case. To exit without changing the description, press the DISP. button.

2. Press ADJ./MEMO.

Press ADJ./MEMO to save the description and exit the keyboard entry dialog.

Troubleshooting

Problem 1 Cannot download images

Solution 1

Your camera may not be recognized correctly if you connect to the USB Port of your computer via a USB hub.

Follow the steps below to change the USB port.

- Connect your camera directly to the USB port of your computer.
- If there are several root hubs, change to another hub.

If you are using a non-USB hub, try connecting via a USB hub.

Solution 2

The battery in the camera may have worn out.

Before downloading images from your camera, load a battery with adequate remaining power in the camera.

Solution 3

The free space on the hard disk in your computer may be insufficient.

Check whether the hard disk has sufficient space for running Windows, and whether the drive where you are loading image files has the same capacity or more as that of the SD memory card inserted in the camera.

Problem 2 Even if you check [The same image will not be saved] in the DL-10 [Option settings], the same images are loaded into your computer.

Solution

The camera's clock is incorrectly set or the camera's clock information has been reset.

To allow the [The same image will not be saved] function to work properly, the camera's clock information must be set properly. Set it properly.

Problem 3 Files loaded from the camera into the computer were deleted. You attempted to load the same files from the camera again but failed.

Solution

If [The same image will not be saved] is checked in the DL-10 [Option settings], files loaded into your computer once cannot be loaded again. In the DL-10 [Option settings], uncheck [The same image will not be saved].

Problem 4 [Failed to save.] appears during image loading from the camera into your computer

Solution

Set the camera to playback mode and check that [Unmatched File] is not displayed for any file. If [Unmatched File] is displayed, delete the file from the SD memory card or internal memory after backing up all files on your computer. To back up the files in the camera, copy all files into your computer directly by using a commercially-available card reader or by connecting the camera to the computer using the USB cable provided.