



Product Guide 2016

- Mounts
- Enclosures
- Kiosks
- Accessories



We Thought of Everything
So You Would Be Ready for Anything



Model: MMA302

MagConnect™ Mounting Solutions

Each MagConnect mount features a patent-pending magnetic connector that makes attaching and removing your tablet rapid and simple. The mounts are crafted of high-quality carbon fiber arms, this advanced material is surprisingly lightweight yet incredibly strong for increased durability and ease of use. The powerful combination of carbon fiber with carefully designed spherical joints produces mounts that are both easy to maneuver and sturdy to use. Paired with a compatible protective case or tray these mounts are ideal for virtually any environment in any circumstance.



Lightweight Durability

MagConnect mounts are built of high-quality carbon fiber arms. This superior material is lightweight and durable. The powerful combinations of carbon fiber with carefully designed joints produce mounts that are both easy to maneuver and sturdy to use.

Highly Flexible

MagConnect mounts come equipped with two spherical joints for multi-angle positioning; one at the top of the mount where the included tablet holder connects to the mount and one at the base. Each joint can rotate 360° to easily position your tablet for optimum ergonomics thus reducing neck and back strain.





Magnetic Ecosystem

Each MagConnect tablet holder is equipped to work with any MagConnect mount and designed to work with Apple SmartCover. And since technology is forever evolving, so is MagConnect. New tablet holders are crafted as new devices are released.

Aluminum Alloy

Each ball joint is carved out of one solid piece of aluminum alloy. This high quality material was selected for it's strength and durability. Ridges are precisely engraved into each ball joint to create friction when the mount arm and tray are secured in place.





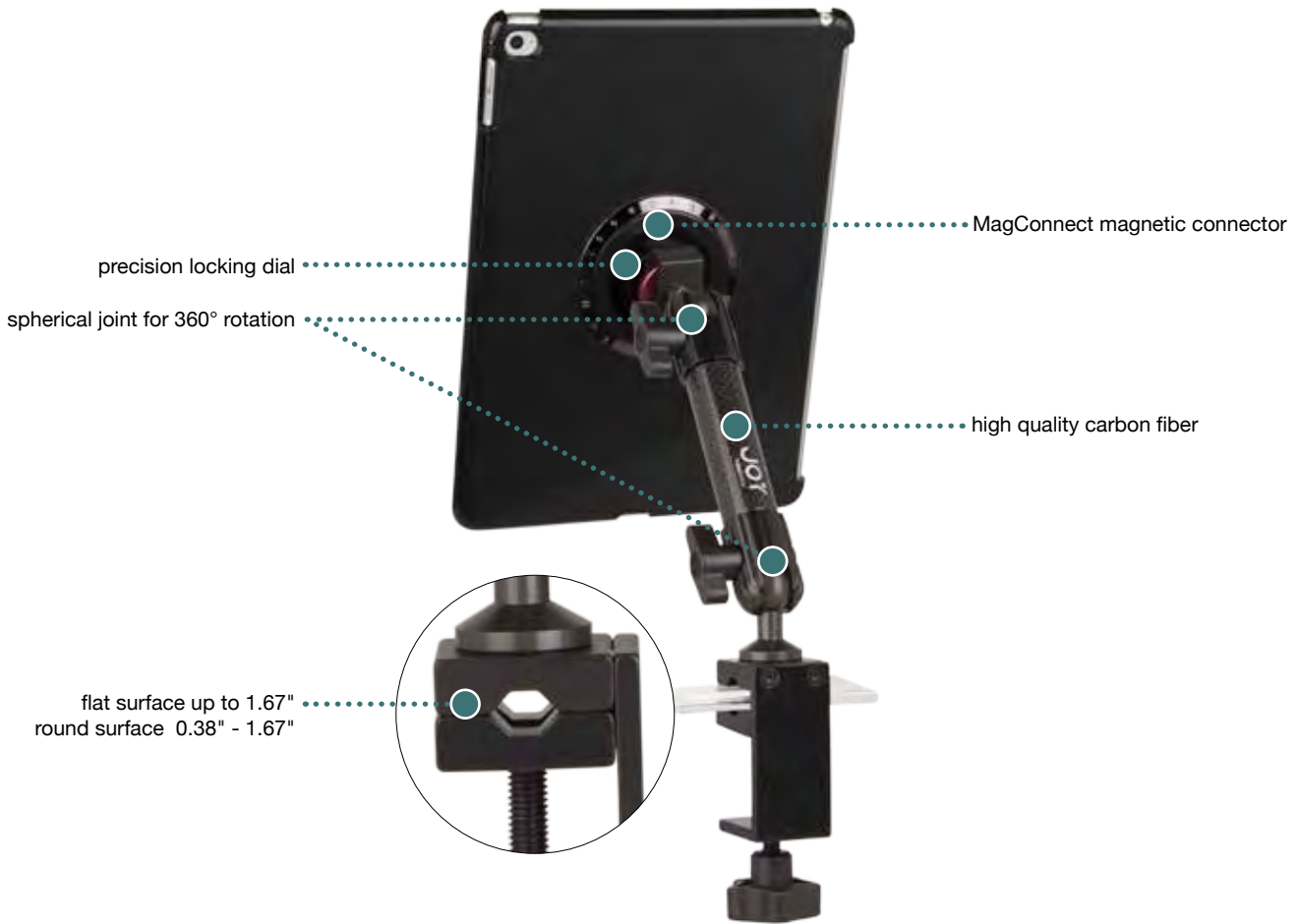

Flat & Round Surface Mount

C-Clamp Mount

The MagConnect C-Clamp Mount is the best solution for attaching an iPad or tablet alike to a round or flat surface. The single carbon fiber arm of the C-Clamp Mount reliably mounts your iPad or tablet while keeping it nearby. This tablet mount is ideal for flat counters, poles, and rods such as warehouse shelving, corporate reception areas, office workspaces, back kitchens, restaurant front counters, creative organizations, and photography studios.







| Enclosure Types | | | Product Information | Technical Information |
|---|--|--|--|--|
|  Standard |  aXtion Edge |  aXtion Bold | Model Number: MMU102 UPC: 817713010260 Compatibility: iPad Pro, iPad Air 2, iPad Air, iPad 4, iPad 3, iPad 2, iPad mini 4, iPad mini 3, iPad mini 2, iPad mini 1, Surface Pro 3, & tablets 7"-12" | Material: Carbon Fiber Weight: 2 lbs. Length: 6" arm x 1 Joints: 1 x spherical joint at base, 1 x spherical joint at tablet connection Base: Flat surfaces up to 1.67" round surfaces 0.38" - 1.67" Warranty: 1 year limited warranty |
|  aXtion Pro |  LockDown |  Universal | | |

Flat Surface Mount

Clamp Mount

This impressive mount attaches to flat surfaces, and extends two carbon fiber arms to mount your tablet in a wide variety of settings. From the nightstand to the conference room, the MagConnect Clamp Mount stands apart from other mounts--it is the ultimate in secure, adjustable excellence in tablet mounting solutions.







| Enclosure Types | | | Product Information | Technical Information |
|---|--|--|--|---|
|  Standard |  aXtion Edge |  aXtion Bold | Model Number: MMU103 UPC: 817713010277 Compatibility: iPad Pro, iPad Air 2, iPad Air, iPad 4, iPad 3, iPad 2, iPad mini 4, iPad mini 3, iPad mini 2, iPad mini 1, Surface Pro 3, & tablets 7"-12" | Material: Carbon Fiber Weight: 2.6 lbs. Length: 10" arm x 2 Joints: 1 x spherical joint at base, 1 x spherical joint at tablet connection Base: Fits flat surfaces up to 1.9", with extended length fits flat surface up to 3" Warranty: 1 year limited warranty |
|  aXtion Pro |  LockDown |  Universal | | |

Horizontal & Vertical Flat Surface Mount

Wall | Cabinet Mount

The MagConnect Wall/Cabinet Mount attaches securely to flat surfaces for permanent installation. Whether you're monitoring patient records at a shared workstation or ensuring quality control in a factory, the Wall | Cabinet is the trusted way to keep your tablet in play and fold away when not in use. Installation is simple: four simple screws affix the mount to a wall stud, cabinet base (mountable base version), or metal surface (magnetic base version).







| Enclosure Types | | | Product Information | Technical Information |
|---|---|---|--|---|
|  |  |  | Model Number: MMU104 UPC: 859974002417 Compatibility: iPad Pro, iPad Air 2, iPad Air, iPad 4, iPad 3, iPad 2, iPad mini 4, iPad mini 3, iPad mini 2, iPad mini 1, Surface Pro 3, & tablets 7"-12" | Material: Carbon Fiber Weight: 1.56 lbs. Length: 5" arm x 1, 4" arm x 1 Joints: Large spherical joint at base x 1, 360° joint between arms x 1, spherical joint at tablet connection x1 Base: Mounts to a flat surface Warranty: 1 year limited warranty |
| Standard | aXtion Edge | aXtion Bold | | |
|  |  |  | | |
| aXtion Pro | LockDown | Universal | | |

Horizontal & Vertical Flat Surface Mount

On-Wall | Counter Mount

The MagConnect On-Wall | Counter Mount for tablets can be attached secured to any flat surface for fixed or permanent installation. This mount features a spherical ball joint at the base allowing the tablet to be positioned to maximize ergonomics. Installation is simple: four screws affix the mount base to any flat surface such as a wall stud, counter or desktop. Experience the joy of worry-free mounting with a On-Wall | Counter Mount.









| Enclosure Types | | | Product Information | Technical Information |
|---|---|---|--|---|
|  |  |  | Model Number: MMU115 UPC: 817713015258 Compatibility: iPad Pro, iPad Air 2, iPad Air, iPad 4, iPad 3, iPad 2, iPad mini 4, iPad mini 3, iPad mini 2, iPad mini 1, Surface Pro 3, & tablets 7"-12" | Material: Weight: 1.5 lbs. Length: Joints: Large spherical joint at base & tablet connection x1 Base: Mounts to a flat surface Warranty: 1 year limited warranty |
|  |  |  | | |
| Standard | aXtion Edge | aXtion Bold | | |
| aXtion Pro | LockDown | Universal | | |

Flat Surface Mount

Desk Stand

Embrace the ergonomic convenience with the Desk Stand. Get more work done, impress clients, and interact with more apps, all at a posture-friendly angle. Your neck and back will thank you. With the MagConnect Desk Stand you have complete power to adjust the stand to your perfect angle--it even folds up completely for easy transport. Perfect for anyone who uses their tablet for any length of time.







| Enclosure Types | | | Product Information | Technical Information |
|---|--|--|--|---|
|  Standard |  aXtion Edge |  aXtion Bold | Model Number: MMU111 UPC: 817713012783 Compatibility: iPad Pro, iPad Air 2, iPad Air, iPad 4, iPad 3, iPad 2, iPad mini 4, iPad mini 3, iPad mini 2, iPad mini 1, Surface Pro 3, & tablets 7"-12" | Material: Carbon Fiber Weight: 1 lbs. Length: 6" arm x 1 Joints: 1 x spherical joint at base, 1 x spherical joint at tablet connection Warranty: 1 year limited warranty |
|  aXtion Pro |  LockDown |  Universal | | |

Document Camera Mount

Illustrate Document Camera

If a picture is worth a thousand words...how about live video and words! Illustrate Document Camera is the ultimate solution for presenting and annotating live video in the classroom or lecture hall using a tablet. The Illustrate tablet stand and the free Illustrate app combine to make demonstrating your important ideas easier than ever.







| Enclosure Types | | | Product Information | Technical Information |
|---|---|---|--|--|
|  |  |  | Model Number: MMU112 UPC: 817713010451 Compatibility: iPad Pro, iPad Air 2, iPad Air, iPad 4, iPad 3, iPad 2, iPad mini 4, iPad mini 3, iPad mini 2, iPad mini 1, Surface Pro 3, & tablets 7"-12" | Material: Aluminum Weight: 5.7 lbs. Length: Extended 19.25", Retracted 14.75" Base: 13" wide x 17.75" long Joints: 1 x spherical joint at tablet connection Warranty: 1 year limited warranty |
|  |  |  | | |
| Standard | aXtion Edge | aXtion Bold | | |
| aXtion Pro | LockDown | Universal | | |

Studio Mount

Tripod | Mic Stand Mount

More and more artists are experiencing the benefits of using a tablet for creating their artwork. Whether using your tablet on a tripod to take steady images or using with a mic stand as a sheet music replacement, keeping your tablet at the right height and angle is ergonomic, convenient, and multiplies what you can do with these magic devices. A Tripod | Mic Stand mount uses the tools you already have to lift your tablet experience to new heights. Fits all standard tripods and microphone stands.







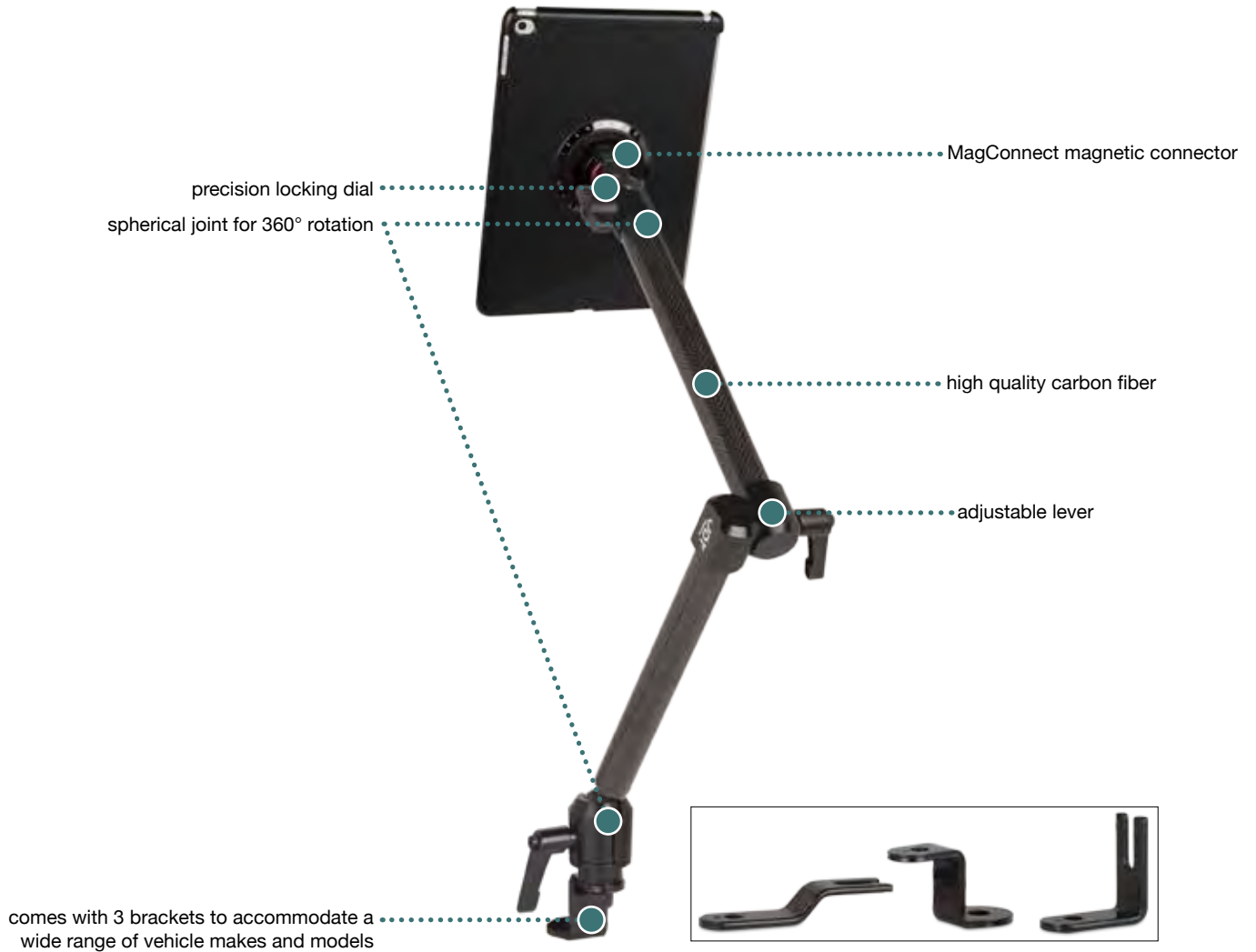

| Enclosure Types | | | Product Information | Technical Information |
|---|--|--|--|---|
|  Standard |  aXtion Edge |  aXtion Bold | Model Number: MMU101 UPC: 817713015425 Compatibility: iPad Pro, iPad Air 2, iPad Air, iPad 4, iPad 3, iPad 2, iPad mini 4, iPad mini 3, iPad mini 2, iPad mini 1, Surface Pro 3, & tablets 7"-12" | Material: Carbon Fiber Weight: less than 1 lb. Length: 6" arm x 1 Joints: 1 x spherical joint at base, 1 x spherical joint at tablet connection Base: Compatible with standard 1/4"-20 tripod connections, standard 5/8"-27 mic stands Warranty: 1 year limited warranty |
|  aXtion Pro |  LockDown |  Universal | | |

Vehicle Mount

Seat Bolt Mount

For an increasingly mobile workforce, a MagConnect Seat Bolt Mount will keep your tablet in the best position for easy access in your car. The mount attaches easily to your car's existing hardware and is compatible with a wide range of makes and models. Adjusts to your preferred position, and folds away when not in use. Perfect for those who use mobile apps to navigate their on-the-go job.







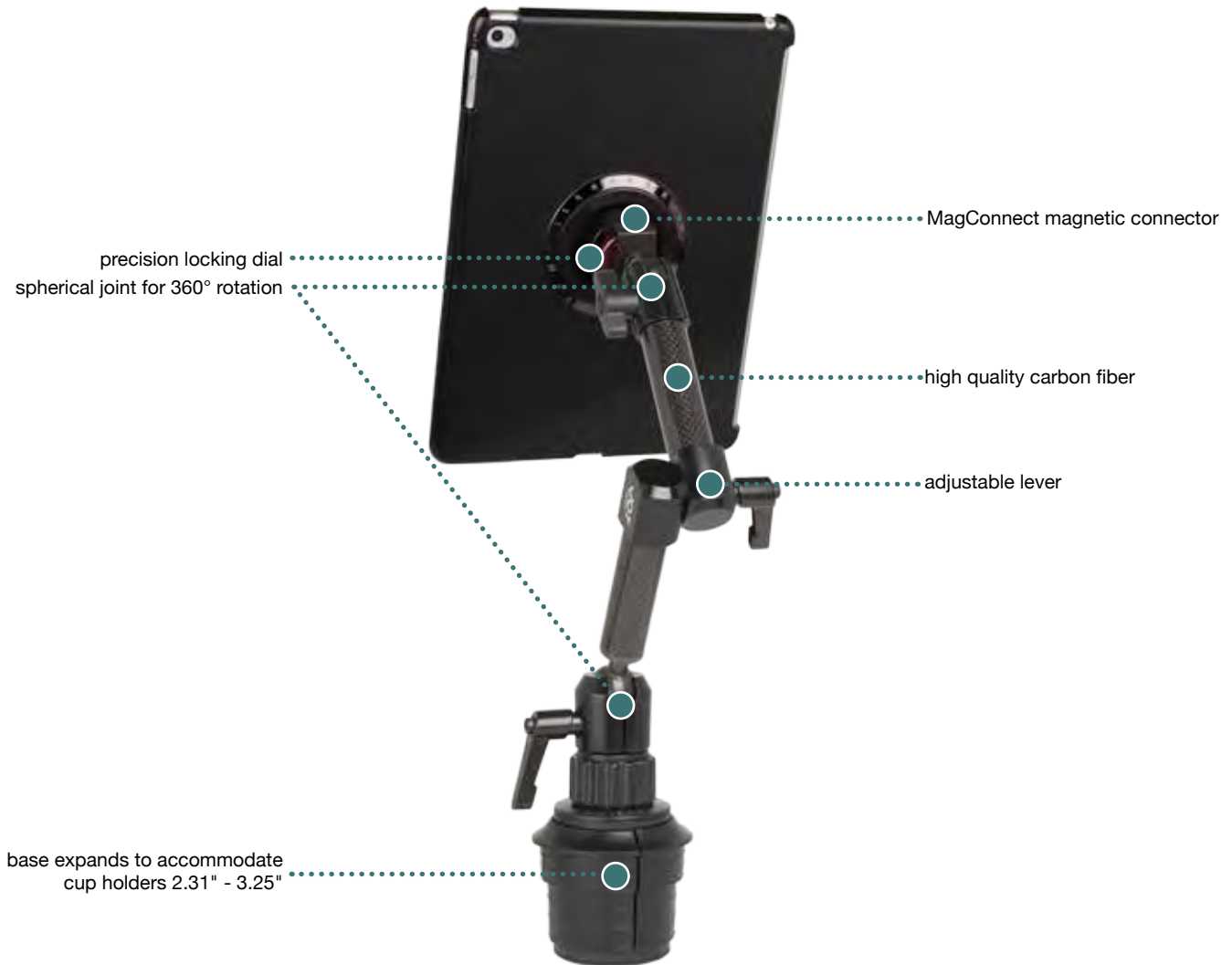

| Enclosure Types | | | Product Information | Technical Information |
|---|---|---|--|--|
|  |  |  | Model Number: MMU105 UPC: 817713010291 Compatibility: iPad Pro, iPad Air 2, iPad Air, iPad 4, iPad 3, iPad 2, iPad mini 4, iPad mini 3, iPad mini 2, iPad mini 1, Surface Pro 3, & tablets 7"-12" | Material: Carbon Fiber Weight: 1.5 lbs. Length: 10" arm x 2 Joints: 1 x spherical joint at base, 1 x 360° joint between arms, 1 x spherical joint at tablet connection Base: 3 brackets included 1 x 45° bracket, 1 x 90° bracket, 1 x 180° bracket Warranty: 1 year limited warranty |
| Standard | aXtion Edge | aXtion Bold | | |
|  |  |  | | |
| aXtion Pro | LockDown | Universal | | |

Vehicle Mount

Cup Holder Mount

Now you can mount your tablet in the car for ultimate convenience with this innovative solution. It expands to fit most standard auto cup holders, so it is compatible with the widest range of automobiles. Whether looking up directions in the front seat or entertaining passengers in the back, the Cup Holder Mount is the best way to unleash your tablet on the road, safely and conveniently.









| Enclosure Types | | | Product Information | Technical Information |
|---|---|---|--|---|
|  |  |  | Model Number: MMU108 UPC: 817713012387 Compatibility: iPad Pro, iPad Air 2, iPad Air, iPad 4, iPad 3, iPad 2, iPad mini 4, iPad mini 3, iPad mini 2, iPad mini 1, Surface Pro 3, & tablets 7"-12" | Material: Carbon Fiber Weight: 1 lb. Length: 4.75" arm x 1, 5.25" arm x 1 Joints: 1 x spherical joint at base, 1 x spherical joint at tablet connection Base: Fits standard cup holder 2.31" - 3.25" Warranty: 1 year limited warranty |
|  |  |  | | |
| Standard | aXtion Edge | aXtion Bold | | |
| aXtion Pro | LockDown | Universal | | |

Vehicle Mount

Headrest Mount

Bring the magic of the tablet to your car's back seat. Use your tablet as an in-car movie theater for long trips or type e-mails during your carpool to work. The Headrest Mount attaches easily to most standard headrest poles so that you can swivel the tablet anywhere you like, even between the front seats. The Mount can be attached to the middle or top section of the poles without affecting headrest adjustments. Proprietary MagConnect™ technology makes attaching your tablet a snap, for a secure connection every time.









| Enclosure Types | | | Product Information | Technical Information |
|---|---|---|--|--|
|  |  |  | Model Number: MMU106 UPC: 817713010307 Compatibility: iPad Pro, iPad Air 2, iPad Air, iPad 4, iPad 3, iPad 2, iPad mini 4, iPad mini 3, iPad mini 2, iPad mini 1, Surface Pro 3, & tablets 7"-12" | Material: Carbon Fiber Weight: 1 lbs. Length: 6" arm x 1 Joints: 1 x spherical joint at base, 1 x spherical joint at tablet connection Base: Adjusts to any round surface maximum 0.75" and minimum 0.38" Warranty: 1 year limited warranty |
|  |  |  | | |
| Standard | aXtion Edge | aXtion Bold | | |
| aXtion Pro | LockDown | Universal | | |

Wheelchair Mount

Wheelchair Mount

The Joy Factory is proud to offer tablet mounts for users with special needs. Users will experience the magic of using assistive technology without having to hold up their device. Those who use the tablet for long periods of time can now do so with limited fatigue and with better posture. Designed from the suggestions of wheelchair users, Wheelchair Mount's double-armed design adjusts to a wide variety of angles and can fold away when not in use.







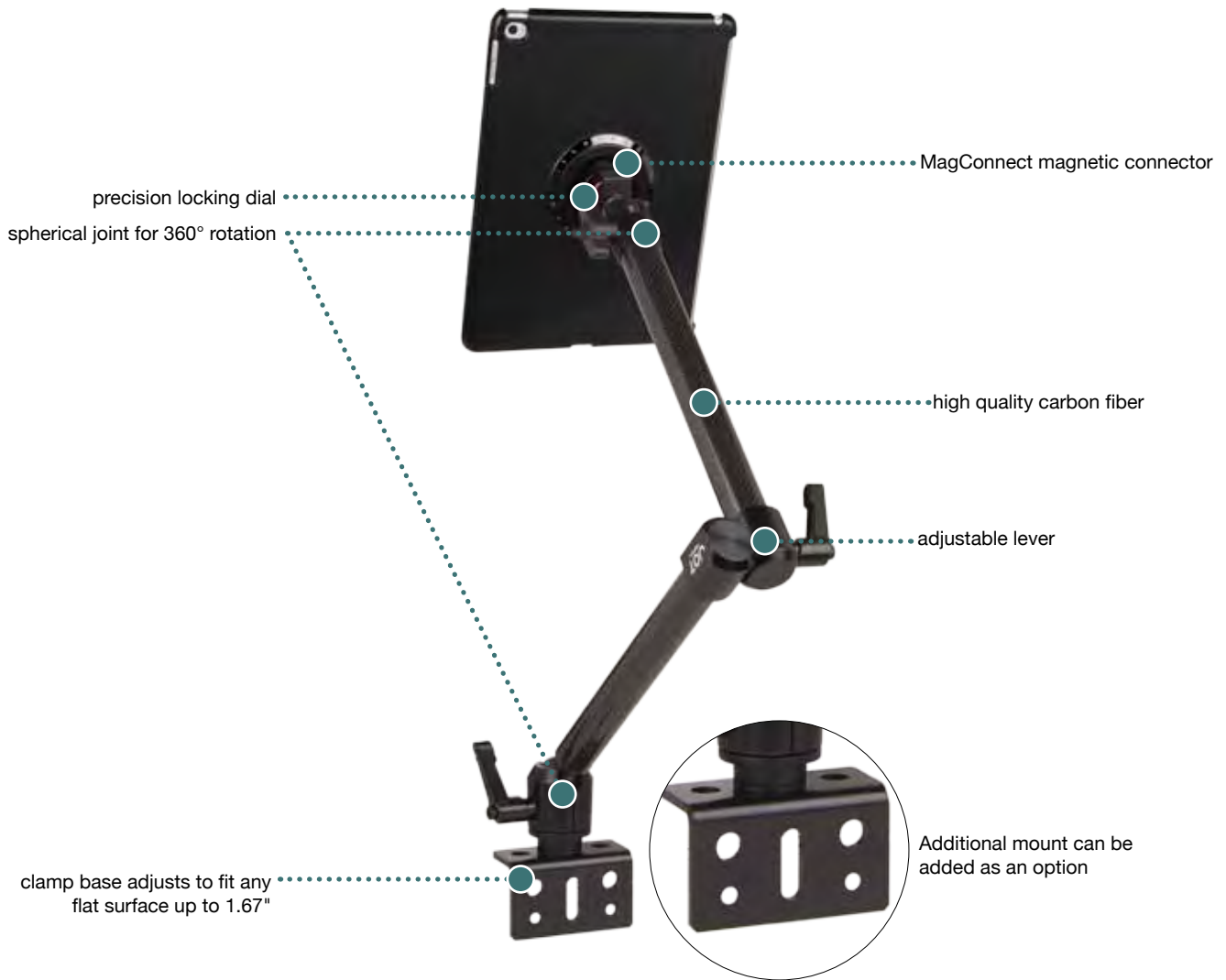

| Enclosure Types | | | Product Information | Technical Information |
|---|---|---|--|---|
|  |  |  | Model Number: MMU109 UPC: 817713012530 Compatibility: iPad Pro, iPad Air 2, iPad Air, iPad 4, iPad 3, iPad 2, iPad mini 4, iPad mini 3, iPad mini 2, iPad mini 1, Surface Pro 3, & tablets 7"-12" | Material: Carbon Fiber Weight: 1.5 lbs. Length: 6" arm x 2 Joints: 1 x spherical joint at base, 1 locking 360° joint between arms, 1 x spherical joint at tablet connection Base: Fits flat surfaces up to 1 5/8" and round surfaces from 11/32" to 1 5/8" Warranty: 3 year limited warranty |
|  |  |  | | |

Wheelchair Mount

Wheelchair Rail Mount

The MagConnect Wheelchair Rail Mount helps bridge the gap between what a user can do with a device and their restricted mobility. This mount is designed with carbon fiber arms to provide lightweight durability and adjustable joints for the perfect position. When it is not in use, the arms can easily be stowed or removed.



| Enclosure Types | | | Product Information | Technical Information |
|---|---|---|--|--|
|  |  |  | Model Number: MMU114 UPC: 817713014749 Compatibility: iPad Pro, iPad Air 2, iPad Air, iPad 4, iPad 3, iPad 2, iPad mini 4, iPad mini 3, iPad mini 2, iPad mini 1, Surface Pro 3, & tablets 7"-12" | Material: Carbon Fiber Weight: 1.5 lbs. Length: 10" arm x 2 Joints: 1 x spherical joint at base, 1 x 360° joint between arms, 1 x spherical joint at tablet connection Base: Fully compatible with Permobil Unitrack's power chairs & other power chairs Other Benefits: Supports up to 2 mounts for easy support of mobile devices Warranty: 3 year limited warranty |
|  |  |  | | |
| Standard | aXtion Edge | aXtion Bold | | |
| aXtion Pro | LockDown | Universal | | |

Redefine Your Limits



Model: CWM100

Enclosure Types

aXtion™ Rugged Enclosures

Each aXtion enclosure is lightweight and rugged, and equipped with a MagConnect port. Having a MIL STD 810 drop test rating means it has been tested to withstand infrequent, non-repetitive drops from 4ft (1.2m). Sometimes rugged means bulky, but not when it comes to aXtion. We utilize the least amount of materials possible which in turn creates a lightweight slim profile. Equipped with a MagConnect connector means the enclosure will work with any of our proprietary MagConnect mounts right out of the box.



aXtion™ Edge Family

This family of enclosures offer all the standard specs the aXtion line has to offer. What makes this family unique is that it is designed for Surface products.



aXtion™ Bold Family

This family of enclosures offer all the standard specs the aXtion line has along with these additional features; a built-in rotating hand strap and 4-way stand and water-resistant. Both on and off the mount these enclosures streamline your workspace.



aXtion™ Pro Family

This family of enclosures offer all the standard specs the aXtion line plus the added waterproof protection. From education to manufacturing this enclosure is ready for anything in virtually any environment.

LockDown Security Enclosures

Offering peace of mind while displaying your device in public spaces is at the core of this enclosure family. Each unit comes equipped with a lockable backing with a cable that is tethered to an unmovable object.



Universal Enclosures

Ideal for environments with multiple devices being utilized. With an ever expanding line up of enclosures we are always working to expand these enclosures to meet the demands as devices are launched.



Rugged Enclosures

aXtion™ Edge

Designed with added protection at the corners to provide drop protection without adding bulk. Each enclosure is designed to nestle around your specific device so added features such as a stylus holder and heat channeling is added when needed based on the device specifications.



Product Information

Model: aXtion Edge M
Model Number: CWM100 | CWM200
UPC: 817713011854 | 859974002714
Compatibility: Surface Pro 3 | 4

Technical Information

Material: Silicone
Weight: 14 oz
Measurements: 8.8" x 12"
Protection: Shockproof rating: MIL-STD-810G
Warranty: 1 year limited warranty

Rugged & Water-Resistant Enclosures

aXtion™ Bold

A built-in screen protector takes this aXtion family beyond rugged with added water-resistance. Each aXtion Bold series features unique features including: built-in rotating hand strap and 4-way stand and MagConnect adapter. Other features available depending on the model.

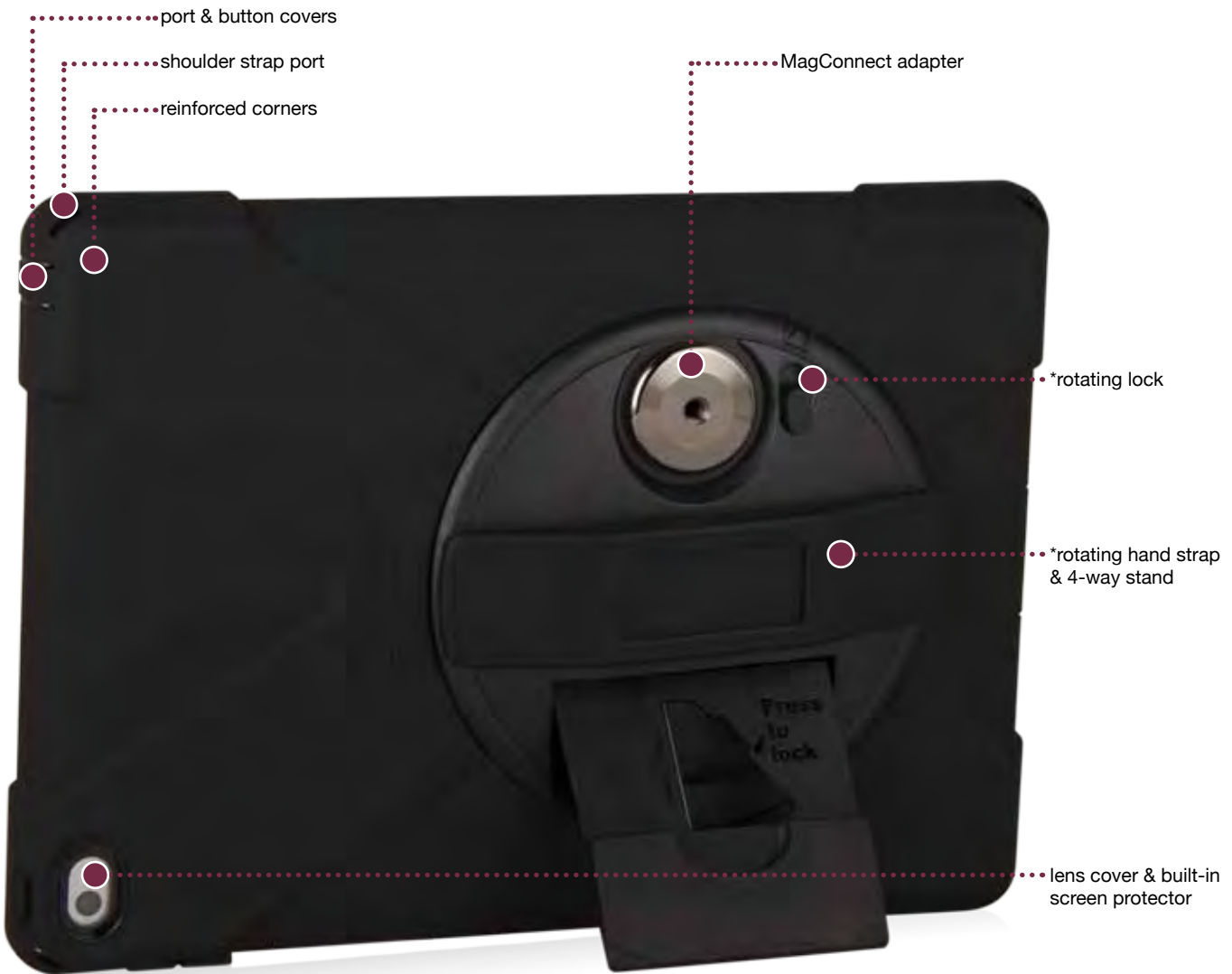

*not all models will have this feature

| Product Information | Technical Information |
|--|--|
| <p>Model: aXtion Bold Model Number: CWM217B CWM206MP CWM203M UPC: 817713014756 817713011687 817713012240 Compatibility: iPad Air 2 iPad Air iPad mini 3 2 1</p> | <p>Material: Silicon Weight: 14 oz (iPad Air 2 & Air) 8 oz (iPad mini 3 2 1) Measurements: 7.17" x 9.8" (iPad Air 2 & Air) 5.6" x 8.2" (iPad mini 3 2 1) Protection: Shockproof rating: MIL-STD-810G, water-resistant Warranty: 1 year limited warranty</p> |

Rugged & Waterproof Enclosures

aXtion™ Pro

Unleash your iPad Air in environments never before thought possible with the aXtion Pro for iPad Air. Fully waterproof, completely shockproof, this case maximizes what the iPad can do in businesses, hospitals, schools, homes, and more.



| Product Information | Technical Information |
|---|--|
| <p>Model: aXtion Pro Model Number: CWA209 UPC: 817713010819 Compatibility: iPad Air</p> | <p>Weight: 20.8 oz Measurements: 8.3" x 11.2" Protection: Shockproof rating: MIL-STD-810G, IP68 Waterproof Warranty: 1 year limited warranty</p> |

Lockable Enclosures

LockDown™

LockDown is a secure case that cradles your iPad in safety, tethered by a cable lock (included) to an immovable object. Just unlock the cable lock with the included keys, insert the iPad, close, and lock. It's that simple.

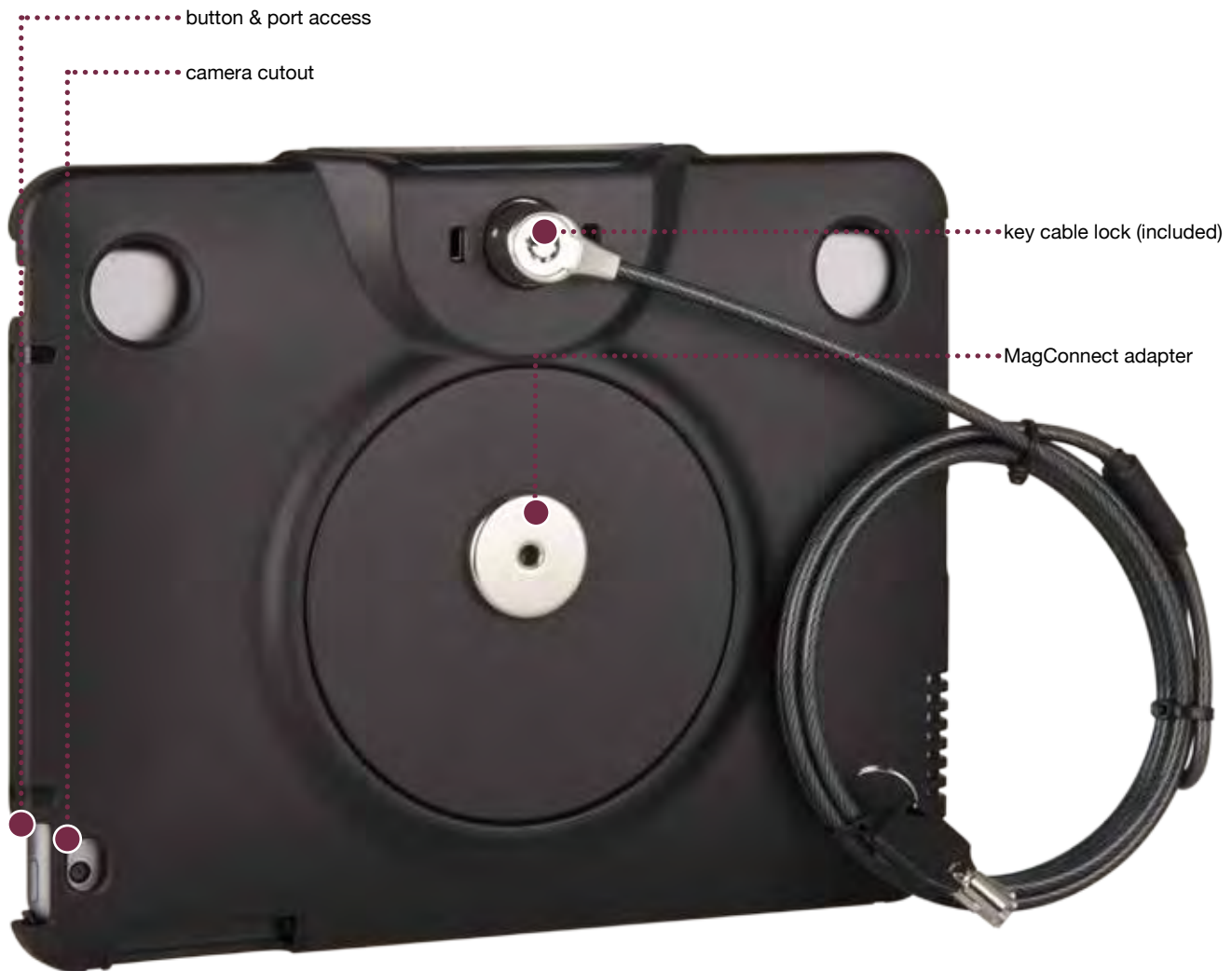

| Product Information | Technical Information |
|--|---|
| <p>Model: LockDown Model Number: MMA110 UPC: 817713011700 Compatibility: iPad Air & iPad 4 3 2</p> | <p>Weight: 0.40 lbs Measurements: 9.8" x 7.8" x 1" Protection: Key lock cable can tether to secure device Warranty: 1 year limited warranty</p> |

Universal Enclosures

Universal

The custom fitted holder secures your device into place for easy access. Despite a compact size, its adjustable clamp type arms are easily extendable to hold a wide range of device sizes.

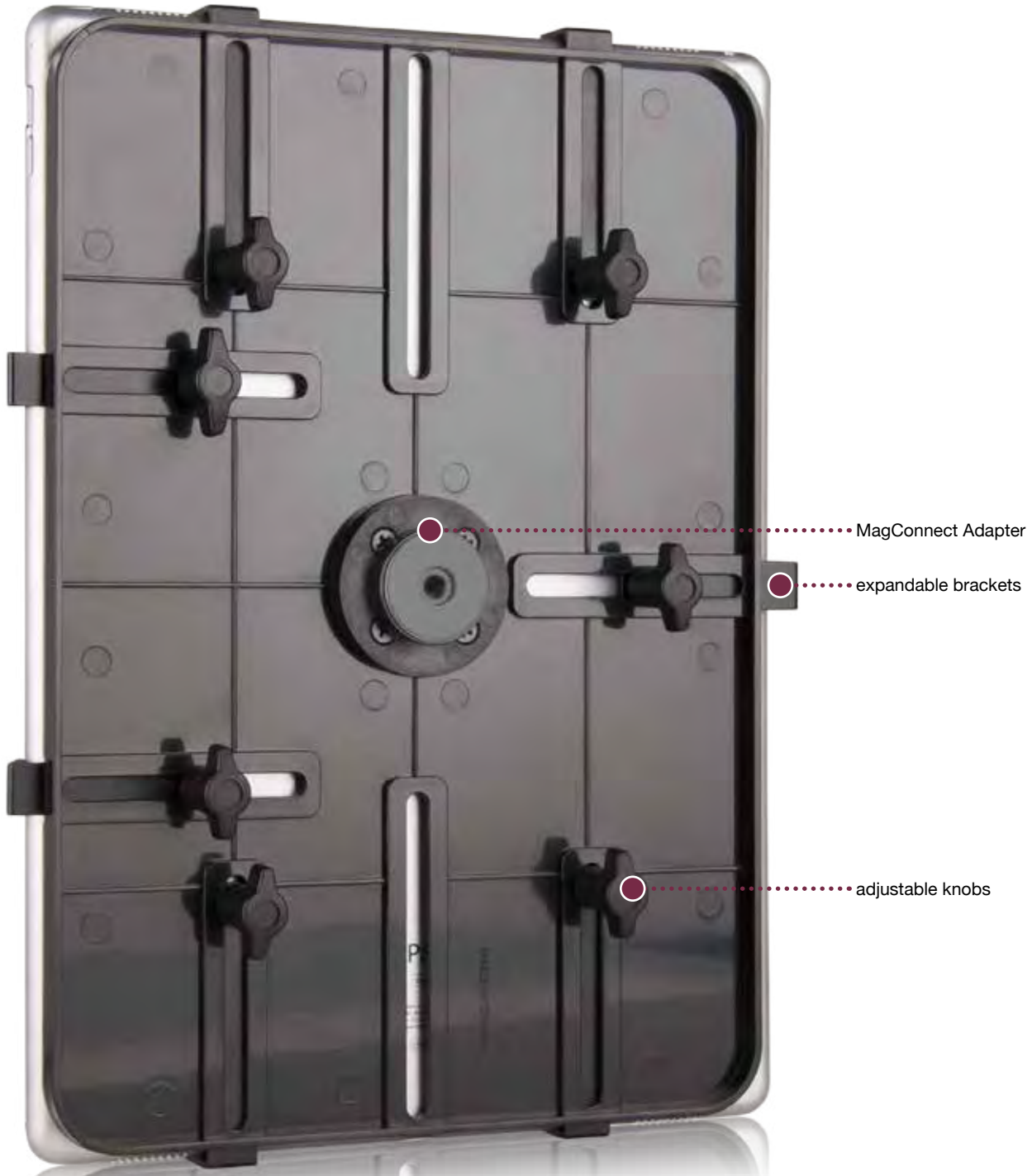

Product Information

Model: Universal
Model Number: MCU106 | MCU107 MMX102
UPC: 817713014763 | 817713014923 | 817713013599
Compatibility: tablets 7" - 12" | tablets 12" - 13" | smartphones 2.25" - 3.5"

Technical Information

Weight: 12 oz (tablet & smartphone holder)
Measurements: 11.75" x 8.25"
Protection: Will hold a device with a rugged case with thicker brackets
Warranty: 1 year limited warranty

Comparison Chart

MagConnect™ Universal Tablet Module

MagConnect Universal Tablet Module is a new mounting system for conveniently mounting tablets, mobile devices and more. Apply the module to the back of any case or device (flat/smooth surface) and instantly your device is prepared for a MagConnect mount.



Product Information

Model: MagConnect™ Universal Tablet Module
Model Number: MMX107
UPC: 859974002943
Compatibility: tablets and cases with a non-porous surface

Technical Information

Weight: 3 oz
Measurements: 6.625" x 3.875"
Adhesive Strength: Industrial Strength, PERMANENT solution
Warranty: 1 year limited warranty

Accessories

Hand Strap

The Universal Hand Strap is designed to work with all enclosures with MagConnect adapters that do not feature a built-in hand strap. This adjustable hand strap is made with a material for added comfort.



Shoulder Strap

This heavy-duty shoulder strap will keep your aXtion case securely attached, so your device is handy when you need it, and your hands are free when you don't! And with the included comfort shoulder pad you'll hardly even notice it's there.



For more information visit us online at www.thejoyfactory.com or contact us at sales@thejoyfactory.com

Product Information

1. Select a Mount

| | |
|----------------------------|--------|
| Tripod/Mic Stand Mount | MMU101 |
| C-Clamp Mount | MMU102 |
| Clamp Mount | MMU103 |
| Wall Cabinet Mount | MMU104 |
| On Wall Mount | MMU115 |
| Seat Bolt Mount | MMU105 |
| Headrest Mount | MMU106 |
| Cup Holder Mount | MMU108 |
| Wheelchair Mount | MMU109 |
| Wheelchair Rail Mount | MMU114 |
| Desk Stand Mount | MMU111 |
| Illustrate Document Camera | MMU112 |

2. Select an Enclosure

MagConnect Standard Tray

| | |
|---------------------|--------|
| iPad Pro | MMA400 |
| iPad Air 2 | MMA300 |
| iPad Air | MMA200 |
| iPad 4 3 2 | MMA101 |
| iPad mini 3 2 1 | MME200 |

aXtion Edge M

| | |
|-------------------|--------|
| for Surface Pro 3 | CWM100 |
| for Surface Pro 4 | CWM200 |

aXtion Bold M

| | |
|-------------------------|---------|
| for iPad mini 3 2 1 | CWE203M |
|-------------------------|---------|

aXtion Bold MP

| | |
|----------------|----------|
| for iPad Air 2 | CWA217B |
| for iPad Air | CWA206MP |

aXtion Pro

| | |
|--------------|--------|
| for iPad Air | CWA209 |
|--------------|--------|

LockDown

| | |
|-------------------------------|--------|
| for iPad Air & iPad 4 3 2 | MMA110 |
|-------------------------------|--------|

MagConnect Universal Tablet Module

| | |
|-----------------------------------|--------|
| for any device or non porous case | MMX107 |
|-----------------------------------|--------|

Universal

| | |
|--------------------------------|--------|
| S1 for 2.25"- 3.5" smartphones | MMX102 |
| 7"-12" tablets | MCU106 |
| 12"-13" tablets | MCU107 |

3. Select an Accessory

| | |
|---------------------------|--------|
| Universal Shoulder Strap | CWX102 |
| Universal Hand Strap | CWX201 |
| Pinpoint Precision Stylus | BCU208 |



The Joy Factory offers business-driven digital companion accessories. The company's namesake is derived from the definition of Joy: the emotion of great delight or happiness caused by something exceptionally good or satisfying. This is the driving philosophy behind the company's commitment to creating an elite class of digital companion products that bridge today's complex technology. We strive to bring optimized workflow, seamless collaboration, increased productivity, and virtual workspaces to our clients.

DuraTech USA Inc.
GSA Schedule 70 GS35F115BA & GSA Schedule 70 GS-35F-0143R
CMAS # 3-15-70-3195A & CMAS # 3-15-70-3195B
Certified 8(a), SDB, DBE, SBE, CUCP, MBE & WBE
Offering Service with Pride & Integrity
Phone: (714) 898-2171 Fax: 866-704-9132
Email: sales@DuraTechUSA.com www.DuraTechUSA.com